

# RG..D..N



## RG 1-phase solid state relays with a communications interface

Communication interface for real time monitoring only



RGC..D..N



RGS..D..N

### Benefits

- **Communications interface.** Solid state relay parameters and diagnostic data are accessible in real time.
- **Reduced maintenance costs and downtime.** Use of real-time data for prevention of machine stoppages during operation.
- **Good quality products and low scrap rates.** Real-time monitoring allows timely decisions for better machine and process management.
- **Reduced efforts in troubleshooting.** Distinguished faults to facilitate and reduce troubleshooting time.
- **Versatile.** Easy integration in existing machines as the control of the solid state relay does not change compared to a solid state relay without a communication interface.
- **Fast installation and set-up.** The solid state relays on the BUS are addressed by Auto- addressing for fast set-up and prevention of incorrect settings.
- **Compact dimensions.** Slimline RG series for a minimum product width of 17.8 mm, 1x DIN, up to 37 AAC at 40°C.

### Description

The **RG..N** solid state relays are the switching components in the NRG BUS chain.

Switching of the **RG..D..N** is controlled by a voltage in the range of 4-32 VDC applied to the specific **RG..D..N**. In addition to the typical switching function of a solid state relay, the **RG..N** has integrated monitoring and a communication interface to provide data of the monitored variables and diagnostic information in real-time. The variables that can be read out from each **RG..D..N** are current, voltage, frequency, power, energy consumption and running hours. The status of each **RG..N** is accessible and in case of an unhealthy status, the specific fault is indicated to facilitate troubleshooting.

The **RG..N** cannot interface directly with the system controller (PLC) but needs to be addressed in an **NRG BUS chain** (as explained further on). 1 **NRG BUS chain** can handle up to 48 **RG..D..Ns**. The first **RG..N** in the BUS chain is connected to the NRG controller, whilst the last **RG..N** in the BUS chain has to be terminated with a BUS terminator provided with the NRG controller.

The **RGC..N** has an integrated heatsink and output ratings go up to 660 VAC, 65 A. The **RGS..N** does not have an integrated heatsink. Maximum output ratings of the **RGS..N** go up to 660 VAC, 90 A. LEDs on the front facade give a visual indication of the status of the **RG..N** output, any ongoing communication and the alarm status of the **RG..N** and its respective load.

Specifications are noted at 25°C unless otherwise specified.

### Applications

Any heating application where reliable and precise maintenance of temperatures is crucial to the quality of the end product. Typical applications include plastic machinery such as injection machines, extrusion machines and PET blow moulding machines, packaging machinery, sterilisation machinery, drying tunnels and semiconductor manufacturing equipment.

### Main function

- 1-phase AC zero cross solid state relays up to 660 VAC, 90 AAC
- 4-32 VDC control for switching of the solid state relay
- Communications interface for real-time monitoring

## The NRG system

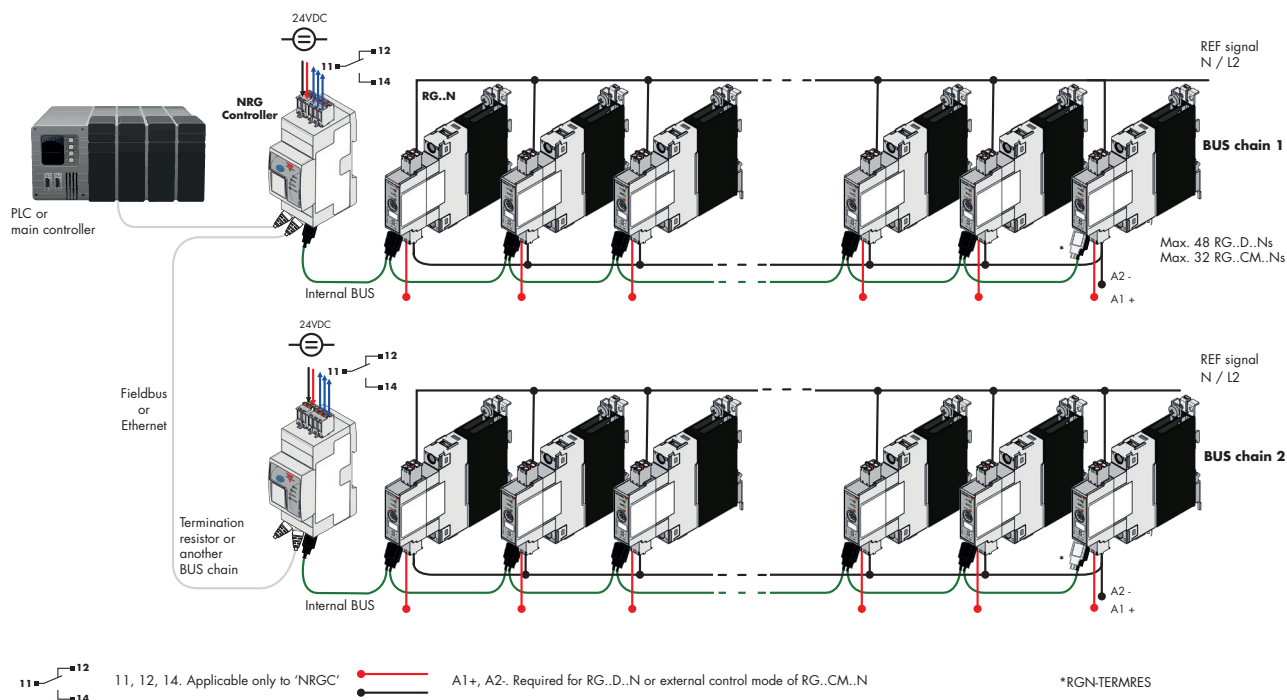

### System Overview

The NRG is a system consisting of one or more BUS chains that enable communication between the field devices (such as the solid state relays) and the control devices (such as the machine controller or PLC).

Each **NRG BUS** chain consists of the following 3 components:

- the NRG controller
- the NRG solid state relay(s)
- the NRG internal BUS cables

The **NRG controller** is the interface to the machine controller. It acts as the master of the BUS chain when performing specific actions on the respective BUS chain, and acts as a gateway for the communication between the PLC and the RG..N solid state relays. It is not possible to operate the NRG system without the NRG controller.

The NRG controllers available are:

- **NRGC**

The NRGC is a NRG controller with a Modbus RTU interface over RS485. The NRGC is addressed via the assigned Modbus ID (from 1-247). In a NRG system operating on Modbus it is possible to have 247 NRG BUS chains.

- **NRGC-PN**

NRGC-PN is a NRG controller with a PROFINET communication interface. The NRGC-PN is identified by a unique MAC address which is printed on the facade of the product. The GSD file can be downloaded from [www.gavazziautomation.com](http://www.gavazziautomation.com)

- **NRGC-EIP**

NRGC-EIP is a NRG controller with an EtherNet/IP communication interface. The IP address is provided automatically via a DHCP server. The EDS file can be downloaded from [www.gavazziautomation.com](http://www.gavazziautomation.com)

- **NRGC-ECAT**

NRGC-ECAT is a NRG controller with an EtherCAT communication interface. The ESI file can be downloaded from [www.gavazziautomation.com](http://www.gavazziautomation.com)

- **NRGC-MBTCP**

NRGC-MBTCP is a NRG controller with a Modbus TCP communication interface.

## System Overview - continued

The **NRG solid state relay** is the switching component in the NRG system. Each **RG..N** integrates a communication interface to exchange data with the machine controller (or PLC). The available RG..Ns that can be used in an NRG system are:

- **RG..D..N**

The RG..D..N are solid state relays for use in an NRG system having the communication interface only for real time monitoring. Control of the RG..N is done via a DC control voltage. It is possible to have maximum 48 **RG..D..Ns** in one NRG BUS chain.

- **RG..CM..N**

The RG..CM..N are solid state relays for use in an NRG system having a communication interface for control of the RG..N through the BUS and for real time monitoring. It is possible to have a maximum of 32 RG..CM..N in one NRG bus chain. There are two variants of the RG..CM..N:

**RGx1A..CM..N** - the solid state relay with zero cross switching

**RGx1P..CM..N** - the solid state relay with proportional switching.

For a review of the features available in both variants refer to the table below:

Feature	RGx1A..CM..N	RGx1P..CM..N
External control	●	-
ON / OFF switching	●	●
Burst switching	●	●
Distributed full cycle switching	●	●
Advanced full cycle switching	●	●
Phase angle	-	●
Soft start with time mode	-	●
Soft start with current limit mode	-	●
Voltage compensation	-	●
Monitoring of system parameters	●	●
SSR diagnostics	●	●
Load diagnostics	●	●
Overtemperature protection	●	●

It is not possible to mix RG..D..N and RG..CM..N in the same BUS chain.

The **NRG internal BUS cables** are proprietary cables that connect the NRG controller to the first RG..N in the NRG BUS chain and respective RG..Ns on the BUS. The internal BUS terminator, provided in the same package with the NRG controller, shall be plugged to the last RG..N in the NRG BUS chain.

## NRG system required components

Description	Component code	Notes
<b>Solid state relays</b>	RG..N	NRG solid state relays
<b>NRG controller</b>	NRGC..	<ul style="list-style-type: none"> <li>• <b>NRGC</b>: NRG controller with Modbus communication.</li> <li>• <b>NRGC-PN</b>: NRG controller with PROFINET communication.</li> <li>• <b>NRGC-EIP</b>: NRG controller with EtherNet/IP communication.</li> <li>• <b>NRGC-ECAT</b>: NRG controller with EtherCAT communication.</li> <li>• <b>NRGC-MBTCP</b>: NRG controller with Modbus TCP communication.</li> </ul> 1x RGN-TERMRES is included in the NRGC.. packaging. The RGN-TERMRES is to be mounted on the last RG..N on the bus chain.
<b>NRG internal BUS cables</b>	RCRGN-xxx	Proprietary cables terminated at both ends with a micro USB connector



**List of contents**

**RG..D..N**

References .....	5
Structure .....	7
General data .....	8
RGS output specifications .....	8
RGC output specifications .....	9
Input specifications .....	9
Internal bus .....	10
Output power dissipation .....	10
RGS heatsink selection .....	11
RGS thermal data .....	11
RGC current derating .....	12
RGC derating vs. spacing .....	12
Compatibility and conformance .....	14
Filter connection diagram .....	15
Filtering .....	15
Environmental specifications .....	16
Measurements .....	17
LED indicators .....	17
Alarm management .....	18
Short circuit protection .....	19
Dimensions .....	21
Connection diagrams .....	24
Functional diagram .....	25
Mounting .....	26
Installation .....	27
Connection specifications .....	28

<b>RCRGN .....</b>	<b>30</b>
--------------------	-----------



## References

### Order code

 RG  1A60D   EN

Enter the code entering the corresponding option instead of

Code	Option	Description	Notes
R	-	Solid State Relay (RG)	
G	-		
<input type="checkbox"/>	C	Version with integrated heatsink	
	S	Version without heatsink	
1	-	Number of poles	
A	-	Switching mode: zero cross	
60	-	Rated voltage: 600 VAC (42-660 VAC) 50/60 Hz	
D	-	Control voltage: 4-32 VDC	
<input type="checkbox"/>	25	Rated current - 25 AAC	For RGC..only
	32	Rated current - 30 AAC, 37 AAC	For RGC..only
	42	Rated current - 43 AAC	For RGC..only
	62	Rated current - 65 AAC	For RGC..only
	50	Rated current - 50 AAC	For RGS..only
	92	Rated current - 90 AAC	For RGS..only
<input type="checkbox"/>	K	Screw connection for power terminals	
	G	Box clamp connection for power terminals	
E	-	Connection configuration	
N	-	For integration within an NRG system	

### Selection guide - versions with integrated heatsink (RGC)

Rated voltage	Control voltage	Connection power	Rated operational current @ 40°C				
			25 AAC	30 AAC	37 AAC	43 AAC	65 AAC
			Product width				
			17.8 mm	17.8 mm	17.8 mm	35 mm	70 mm
600 VACrms	4 - 32 VDC	Screw	RGC1A60D25KEN	RGC1A60D32KEN	-	-	-
		Box clamp	-	-	RGC1A60D32GEN	RGC1A60D42GEN	RGC1A60D62GEN



### Selection guide - versions without heatsink (RGS)

Rated voltage	Control voltage	Connection power	Maximum rated operational current				
			50 AAC	90 AAC	-	-	-
			Product width				
			17.8 mm	17.8 mm		-	-
600 VACrms	4 - 32 VDC	Screw	RGS1A60D50KEN	RGS1A60D92KEN	-	-	-
		Box clamp	-	RGS1A60D92GEN	-	-	-

**Carlo Gavazzi compatible components**

Description	Component code	Notes
<b>NRG controller</b>	NRGC	NRG controller with Modbus RS485. 1x RGN-TERMRES is included in the NRGC packaging
<b>NRG Internal BUS cables</b>	RCRGN-010-2	10 cm cable terminated at both ends with a microUSB connector. Packed x4 pcs.
	RCRGN-025-2	25 cm cable terminated at both ends with a microUSB connector. Packed x1 pc.
	RCRGN-075-2	75 cm cable terminated at both ends with a microUSB connector. Packed x1 pc.
	RCRGN-150-2	150 cm cable terminated at both ends with a microUSB connector. Packed x1 pc.
	RCRGN-350-2	350 cm cable terminated at both ends with a microUSB connector. Packed x1 pc.
	RCRGN-500-2	500 cm cable terminated at both ends with a microUSB connector. Packed x1 pc.
<b>Termination resistor</b>	RGN-TERMRES	Internal BUS chain terminator. 1 pc. is included in the NRGC packaging
<b>Plugs</b>	RGMREF	Spring plug labelled 'Ref'. Packed x10 pcs. 1 pc. included in the RG..N packaging
	RGM25	Spring plug labelled 'A1 A2'. Packed x10 pcs. 1 pc. included in the RG..N packaging
<b>Heatsinks</b>	RHS...	Heatsinks for RGS models

**Further reading**

Information	Where to find it	
User manual	<a href="http://www.gavazziautomation.com/docs/mt_gh/SSR_UM_NRG.pdf">http://www.gavazziautomation.com/docs/mt_gh/SSR_UM_NRG.pdf</a>	
Datasheet NRG Controller with Modbus RS485 interface	<a href="http://www.gavazziautomation.com/docs/mt_gh/SSR_NRGC.pdf">http://www.gavazziautomation.com/docs/mt_gh/SSR_NRGC.pdf</a>	
Online heatsink selector tool for RGS	<a href="http://gavazziautomation.com/nsc/HQ/EN/solid_state_relays">http://gavazziautomation.com/nsc/HQ/EN/solid_state_relays</a>	



# Structure

RGC..D..N

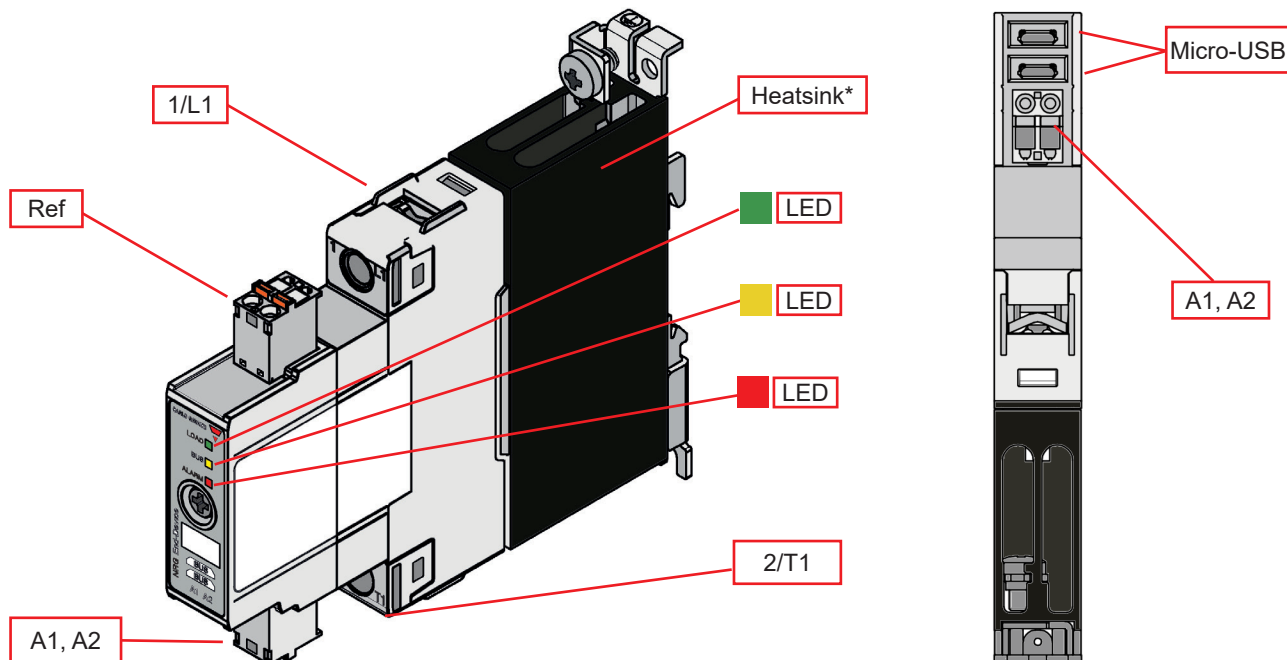

\* integrated for RGC..N versions. RGS..N do not have an integrated heatsink

Element	Component	Function
1/L1	Power connection	Mains connection
2/T1	Power connection	Load connection
Ref	Voltage reference connection	Reference signal (L2 or N) for voltage measurement 2-pole plug internally shorted to allow for looping
A1, A2	Control connection	2-pole plug for control voltage
Green LED	LOAD indicator	Indicates status of RG..N output
Yellow LED	BUS indicator	Indicates ongoing communication
Red LED	ALARM indicator	Indicates presence of an alarm condition
Micro-USB	Micro-USB ports for internal BUS	Interface for RCRGN cable connection for the internal BUS communications line
Heatsink	Integrated heatsink	Integrated for RGC..N versions RGS..N versions do not have an integrated heatsink

## Features

### General data

<b>Material</b>	PA6 or PA66 (UL94 V0), RAL7035 850°C, 750°C/2s according to GWIT and GWFI requirements of EN 60335-1
<b>Mounting</b>	DIN rail (for RGC only) or panel
<b>Touch Protection</b>	IP20
<b>Oversvoltage Category</b>	III, 6 kV (1.2/50 µs) rated impulse withstand voltage
<b>Isolation</b>	Input to Output: 2500 Vrms Input and Output to heatsink: 4000 Vrms
<b>Weight</b>	RGS..50: approx. 170 g RGS..92: approx. 170 g  RGC..25: approx. 310 g RGC..32: approx. 310 g RGC..42: approx. 520 g RGC..62: approx. 1030 g
<b>Compatibility</b>	NRGC (NRG controller with Modbus RS485 interface)

## Performance

### RGS.. Output

	RGS..50..	RGS..92..
<b>Operational voltage range, Ue</b>	42 – 660 VAC	
<b>Switching mode</b>	Zero cross switching	
<b>Max. operational current: AC-51 rating<sup>1</sup></b>	50 AAC	90 AAC
<b>Operational frequency range</b>	50/60 Hz	
<b>Blocking voltage</b>	1200 Vp	
<b>Power factor</b>	> 0.9	
<b>Output overvoltage protection</b>	Integrated varistor across L1-T1	
<b>Leakage current @ rated voltage</b>	< 5 mAAC	
<b>Minimum operational current</b>	300 mAAC 1 AAC (Phase Angle)	500 mAAC 1 AAC (Phase Angle)
<b>Maximum transient surge current (I<sub>TSM</sub>), t=10 ms</b>	600 Ap	1900 Ap
<b>I<sup>2</sup>t for fusing (t=10 ms), minimum</b>	1800 A <sup>2</sup> s	18000 A <sup>2</sup> s
<b>LED indication - LOAD</b>	Green, ON when control output is ON	
<b>Critical dV/dt (@T<sub>j</sub> init = 40°C)</b>	1000 V/µs	

1. Max. rated current with suitable heatsink. Refer to RGS heatsink selection tables.

## RGC.. Output

	RGC..25	RGC..32	RGC..42	RGC..62
Operational voltage range, Ue	42 - 660 VAC			
Switching mode	Zero cross switching			
Max. operational current: AC-51 rating @ 25°C <sup>2</sup>	30 AAC	30 AAC KEN 43 AAC GEN	50 AAC	75 AAC
Max. operational current: AC-51 rating @ 40°C <sup>2</sup>	25 AAC	30 AAC KEN 37 AAC GEN	43 AAC	65 AAC
Operational frequency range	50/60 Hz			
Blocking voltage	1200 Vp			
Power factor	> 0.9			
Output overvoltage protection	Integrated varistor across L1-T1			
Leakage current @ rated voltage	< 5 mAAC			
Minimum operational current	300 mAAC 1 AAC (Phase Angle)	500 mAAC 1 AAC (Phase Angle)		
Maximum transient surge current (I <sub>TSM</sub> ), t=10 ms	600 Ap	1900 Ap		
I <sup>2</sup> t for fusing (t=10 ms), minimum	1800 A <sup>2</sup> s	18000 A <sup>2</sup> s		
LED indication - LOAD	Green, ON when output is ON			
Critical dV/dt (@Tj init = 40°C)	1000 V/μs			

2. Refer to RGC current derating curves for current ratings at different surrounding temperatures.

## Inputs

Control voltage range, Uc: A1, A2	4-32 VDC
Pick-up voltage	3.8 VDC
Drop-out voltage	1 VDC
Maximum reverse voltage	32 VDC
Maximum response time pick-up	½ cycle
Response time drop-out	½ cycle
Input current @ 40°C	See diagram below

Note: The output of the SSR is independent of the communications interface, therefore, the control voltage switches ON/OFF the output of the SSR even when this is not connected to the BUS chain (i.e., the RCRGN cable is not connected or a problematic BUS communication line).

## Input current vs. input voltage

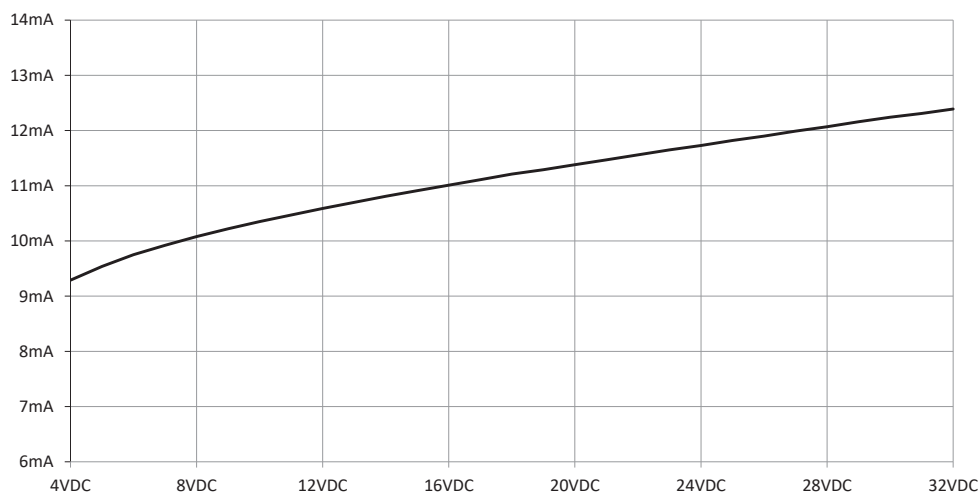

## Internal bus

<b>Supply voltage</b>	Supplied through 2 wires of the RCRGN bus cable when connected to a powered NRG controller
<b>BUS termination</b>	<b>RGN-TERMRES</b> on last device in the bus chain
<b>Max. no. of RG..Ns in a bus chain</b>	48
<b>LED indication - BUS</b>	Yellow, ON during ongoing communication
<b>ID for RG..Ns</b>	Automatic through Auto- addressing (refer to NRG User Manual for further details) Communication is only possible with RG..Ns that are addressed correctly, i.e., they have a valid ID.

## Output power dissipation

**RGS..**

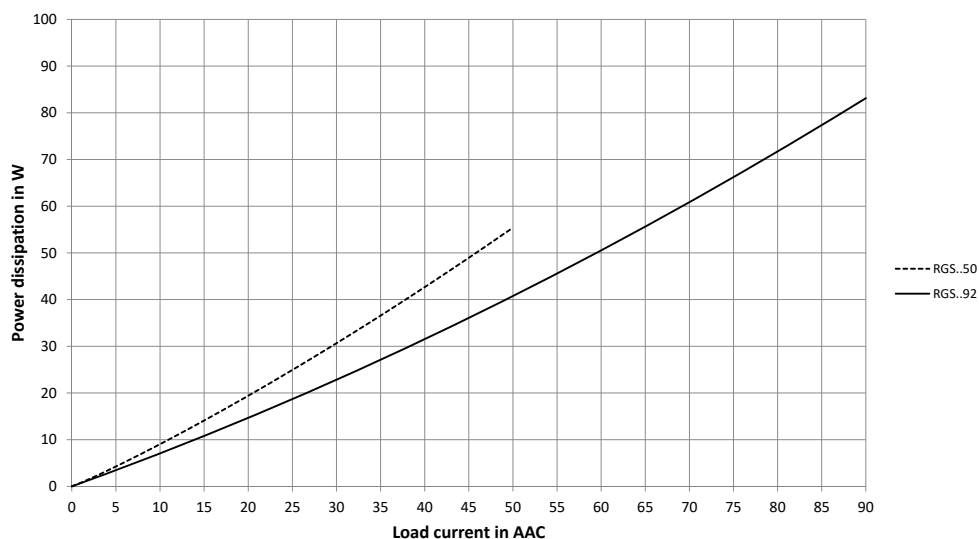

**RGC..**

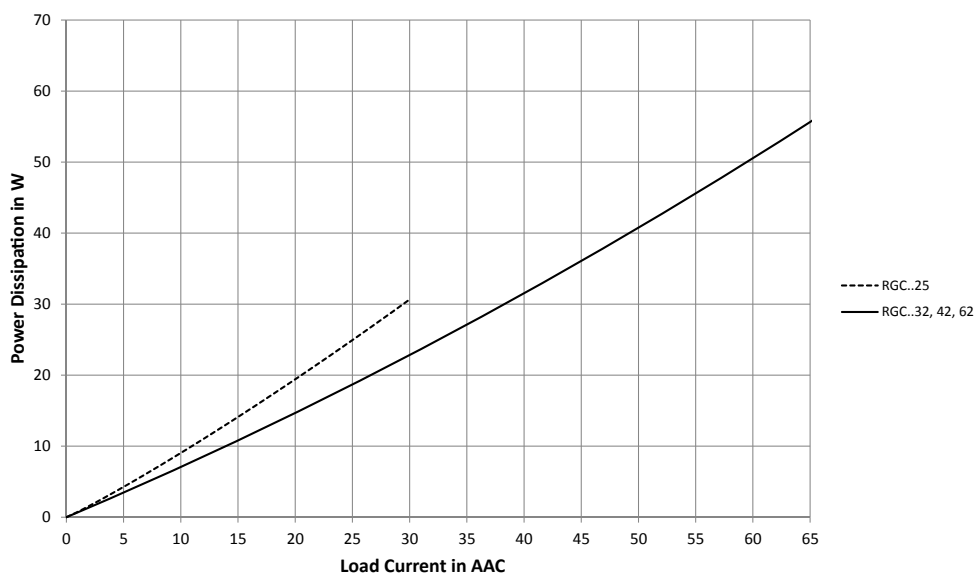

**RGS.. Heatsink selection**

Thermal resistance [°C/W] of RGS..50

Load current per pole AC-51 [A]	Surrounding ambient temperature [°C]					
	20	30	40	50	60	65
50	1.45	1.28	1.06	0.87	0.68	0.59
45	1.72	1.50	1.29	1.07	0.85	0.75
40	2.00	1.75	1.50	1.25	1.00	0.87
35	2.35	2.06	1.76	1.47	1.18	1.03
30	2.83	2.48	2.13	1.77	1.42	1.24
25	3.52	3.08	2.64	2.20	1.76	1.54
20	4.58	4.01	3.44	2.86	2.29	2.01
15	6.40	5.60	4.80	4.00	3.20	2.80
10	10.19	8.92	7.64	6.37	5.10	4.46
5	--	19.51	16.72	13.94	11.15	9.76

Thermal resistance [°C/W] of RGS..92

Load current per pole AC-51 [A]	Surrounding ambient temperature [°C]					
	20	30	40	50	60	65
90	0.62	0.52	0.41	0.31	0.21	0.16
81	0.77	0.66	0.54	0.42	0.31	0.25
72	0.97	0.83	0.70	0.56	0.43	0.36
63	1.23	1.07	0.91	0.75	0.59	0.51
54	1.55	1.35	1.16	0.97	0.77	0.68
45	1.93	1.69	1.45	1.21	0.97	0.85
36	2.53	2.21	1.89	1.58	1.26	1.11
27	3.55	3.11	2.66	2.22	1.77	1.55
18	5.67	4.97	4.26	3.55	2.84	2.48
9	12.46	10.90	9.34	7.79	6.23	5.45

**RGS.. Thermal data**

	RGS..50	RGS..92
Max. junction temperature	125°C	
Heatsink temperature	100°C	
Junction to case thermal resistance, $R_{thjc}$	< 0.30°C/W	< 0.20°C/W
Case to heatsink thermal resistance, $R_{thcs}$	< 0.25°C/W	

**RG.. Current derating**

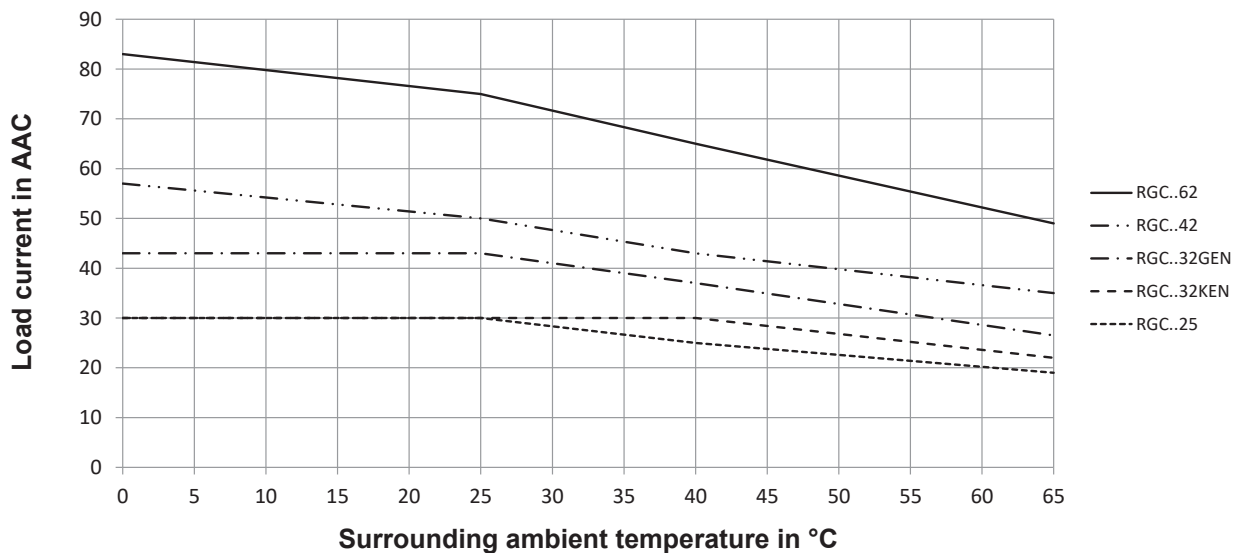

**RG.. Derating vs spacing**

RG...25

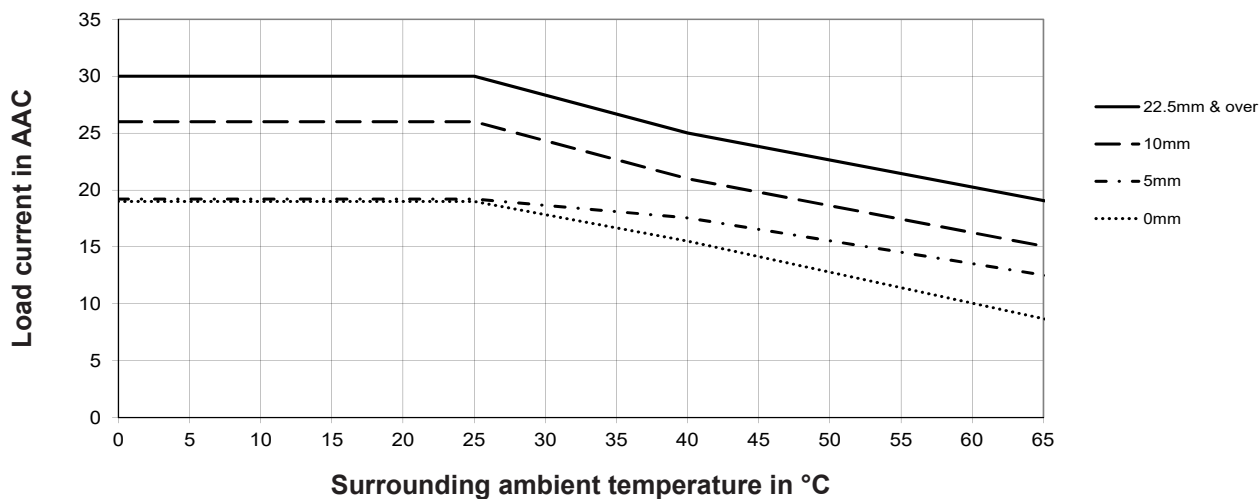



RGC...32

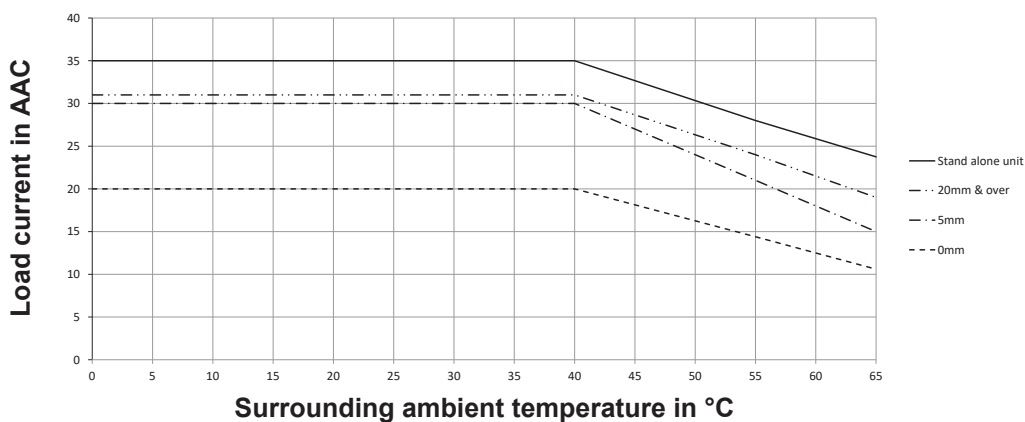



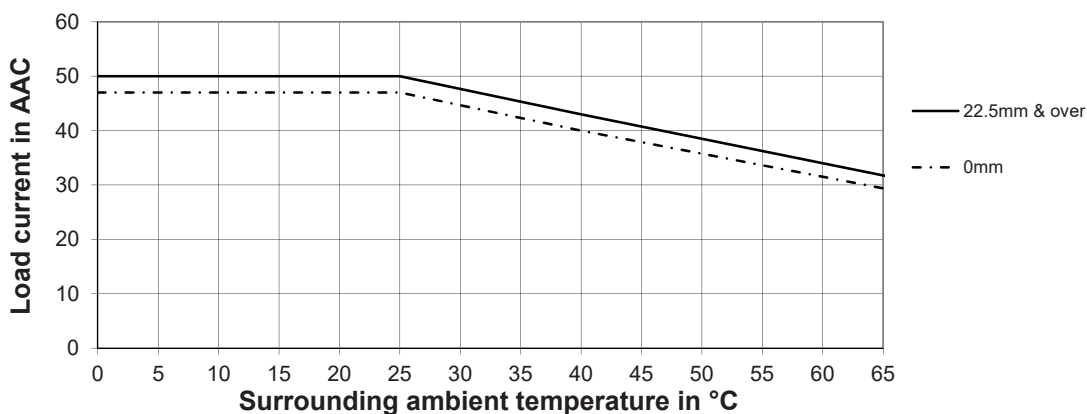



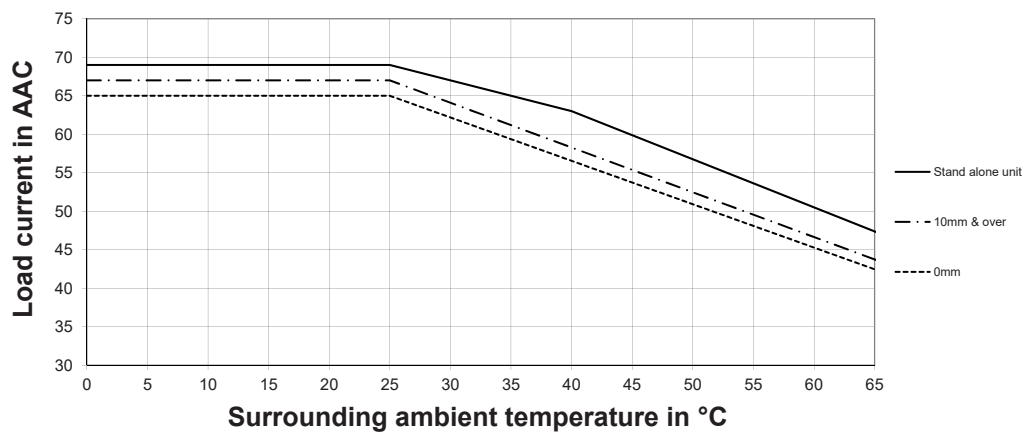





RGC...42



RGC...62



**Compatibility and conformance**

Approvals	RGC:     
	RGS:       
Standards compliance	LVD: EN 60947-4-3 / EE BS EN 60947-4-3 EMCD: EN 60947-4-3 / EMC BS EN 60947-4-3 UL: UL508, E172877, NMFT cUL: C22.2 No. 14-13, E172877, NMFT7 UR: UL508, E172877, NMFT2 (for RGS..N) cUR: C22.2 No. 14-13, E172877, NMFT8 (for RGS..N) CSA: C22.2 No. 14-13, 204075 (for RGS..N) CCC: GB/T 14048.5-2017 (IEC 60947-5-1)
UL short circuit current rating	100 k Arms (refer to short circuit current section, Type 1 – UL508)

Electromagnetic compatibility (EMC) - Immunity	
Electrostatic discharge (ESD)	EN/IEC 61000-4-2 8 kV air discharge, 4 kV contact (PC1)
Radiated radio frequency <sup>3</sup>	EN/IEC 61000-4-3 10 V/m, from 80 MHz to 1 GHz (PC1) 10 V/m, from 1.4 to 2 GHz (PC1) 3 V/m, from 2 to 2.7 GHz (PC1)
Electrical fast transient (burst)	EN/IEC 61000-4-4 Output: 2 kV, 5 kHz & 100 kHz (PC1) Input, BUS: 1 kV, 5 kHz & 100 kHz (PC1)
Conducted radio frequency <sup>3</sup>	EN/IEC 61000-4-6 10 V/m, from 0.15 to 80 MHz (PC1)
Electrical surge	EN/IEC 61000-4-5 Output, line to line: 1 kV (PC2) Output, line to earth: 2 kV (PC2) BUS (Supply), line to line: 500 V (PC2) BUS (Supply), line to earth: 500 V (PC2) BUS (Data), A1-A2, line to earth: 1 kV (PC2) <sup>4</sup>
Voltage dips	EN/IEC 61000-4-11 0% for 0.5, 1 cycle (PC2) 40% for 10 cycles (PC2) 70% for 25 cycles (PC2) 80% for 250 cycles (PC2)
Voltage interruptions	EN/IEC 61000-4-11 0% for 5000 ms (PC2)

3. Under the influence of RF, a reading error of  $\pm 10\%$  was allowed for load currents  $> 500$  mA and  $\pm 20\%$  for load currents  $< 500$  mA. These tolerances are not maintained if Ref signal is not connected.
4. Not applicable to shielded cables  $< 10$  m. Additional suppression on data lines may be required if shielded cables are not used.

Electromagnetic compatibility (EMC) - Emissions	
Radio interference field emission (radiated)	EN/IEC 55011 Class A: from 30 to 1000 MHz
Radio interference voltage emissions (conducted)	EN/IEC 55011 Class A: from 0.15 to 30 MHz (External filter may be required - refer to Filtering section)

Filter connection diagram

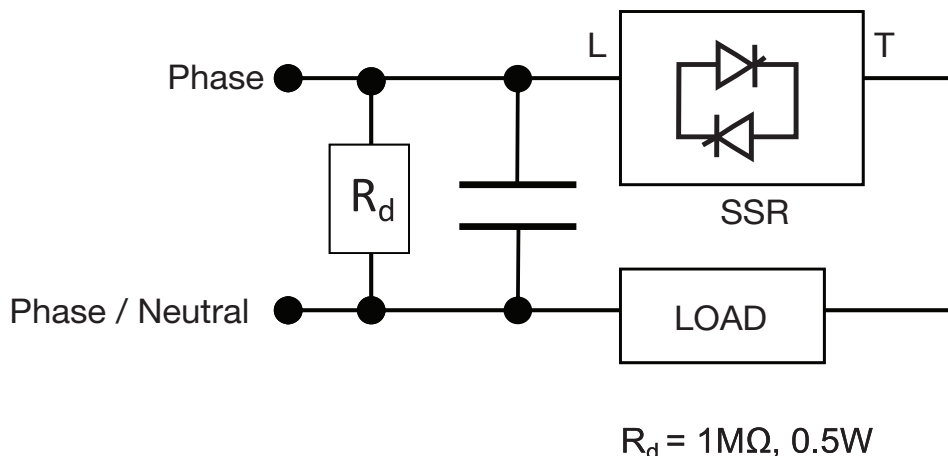

Filtering

Part number	Suggested filter for EN 55011 Class A compliance	Maximum heater current [AAC]
RGS..50..	330 nF / 760 V / X1	30 A
RGS..92..	220 nF / 760 V / X1	30 A
RGC..25..	220 nF / 760 V / X1	30 A
RGC..32..	330 nF / 760 V / X1	40 A
RGC..42.. , RGC..62..	330 nF / 760 V / X1 680 nF / 760 V / X1	40 A 65 A

Note:

- Control input lines must be installed together to maintain products' susceptibility to Radio Frequency interference.
- Use of AC solid state relays may, according to the application and the load current, cause conducted radio interferences. Use of mains filters may be necessary for cases where the user must meet E.M.C requirements. The capacitor values given inside the filtering specification tables should be taken only as indications, the filter attenuation will depend on the final application.
- Performance Criteria 1 (PC1): No degradation of performance or loss of function is allowed when the product is operated as intended.
- Performance Criteria 2 (PC2): During the test, degradation of performance or partial loss of function is allowed. However when the test is complete the product should return operating as intended by itself.
- Performance Criteria 3 (PC3): Temporary loss of function is allowed, provided the function can be restored by manual operation of the controls.

**Environmental specifications**

<b>Operating temperature</b>	-20 to +65 °C (-4 to +149 °F)
<b>Storage temperature</b>	-20 to +65 °C (-4 to +149 °F)
<b>Relative humidity</b>	95% non-condensing @ 40°C
<b>Pollution degree</b>	2
<b>Installation altitude</b>	0-1000 m. Above 1000 m derate linearly by 1% of FLC per 100 m up to a maximum of 2000 m
<b>Vibration resistance</b>	2 g / axis (2-100Hz, IEC60068-2-6, EN 50155)
<b>Impact resistance</b>	15/11 g/ms (EN 50155)
<b>EU RoHS compliant</b>	Yes
<b>China RoHS</b>	

The declaration in this section is prepared in compliance with People's Republic of China Electronic Industry Standard SJ/T11364-2014: Marking for the Restricted Use of Hazardous Substances in Electronic and Electrical Products.

Part Name	Toxic or Harardous Substances and Elements					
	Lead (Pb)	Mercury (Hg)	Cadmium (Cd)	Hexavalent Chromium (Cr(VI))	Polybrominated biphenyls (PBB)	Polybrominated diphenyl ethers (PBDE)
<b>Power Unit Assembly</b>	x	0	0	0	0	0

O: Indicates that said hazardous substance contained in homogeneous materials for this part are below the limit requirement of GB/T 26572.

X: Indicates that said hazardous substance contained in one of the homogeneous materials used for this part is above the limit requirement of GB/T 26572.

这份申明根据中华人民共和国电子工业标准 SJ/T11364-2014：标注在电子电气产品中限定使用的有害物质

零件名称	有毒或有害物质与元素					
	铅 (Pb)	汞 (Hg)	镉 (Cd)	六价铬 (Cr(VI))	多溴化联苯 (PBB)	多溴联苯醚 (PBDE)
<b>功率单元</b>	x	0	0	0	0	0

O:此零件所有材料中含有的该有害物低于GB/T 26572的限定。

X: 此零件某种材料中含有的该有害物高于GB/T 26572的限定。



**Measurements**

Parameter	Register reference	Description
Current	CRRDR	This reports the measured load RMS current.
Hold current	CUHDR	This reports the highest RMS value of current recorded over a number of (past) cycles. The number of past cycles is addressable.
Voltage	VRRDR	RMS voltage reading (L1-Ref voltage) that is the supply voltage across the SSR + load (Ref signal connection is required)
Frequency	FQRDR	This reports the measured line frequency.
Apparent power	APRDR	This reports the apparent power that is a multiplication of the voltage RMS value and current RMS value. (Ref signal connection is required)
Real power	RPRDR	This reports the real power reading that is based on the instantaneous voltage & current multiplications. (Ref signal connection is required)
Running hours (On-time)	OTRDR	This is a count of the time during which the SSR output is ON. On switch ON, this register reports the recorded value at the last switch OFF.
Active Energy	ENRDLR, ENRDHR	This reports the energy reading in kWh. On switch ON, this register reports the recorded value at the last switch OFF. (Ref signal connection is required)

Note 1: For further information please refer to the 'NRG user manual'.

Note 2: Ref signal connection is recommended with loads less than 1A

**LED indicators**

<b>LOAD</b>	Green 	The Load LED reflects the status of the load depending on the presence of the control signal. During an over-temperature condition, the LOAD LED will behave according to the indications in the table "LOAD LED indications in over-temperature condition" below	
<b>BUS</b>	Yellow 	ON:	During a response from the RG..N to the NRG controller
		OFF:	Communication between the NRG controller and RG..Ns is idle or during the transmission of a command from the NRG controller to the RG..N
<b>ALARM</b>	Red 	ON:	Fully ON or flashing when alarm condition is present. Refer to Alarm Management section
		OFF:	No alarm condition

**LOAD LED indications in over-temperature condition**

Control signal A1, A2	RG..N supply (through internal bus by RCRGN..)	Over-temperature condition	LOAD LED green 
ON	OFF	Detection not possible without BUS connected	ON
ON	ON	OFF	ON
ON	ON	ON	OFF
OFF	OFF	Detection not possible without BUS connected	OFF
OFF	ON	ON	OFF
OFF	ON	OFF	OFF

**Alarm management**

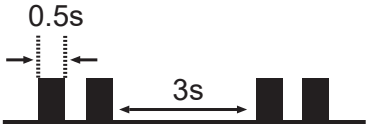
<p><b>Alarm condition present</b></p>	<ul style="list-style-type: none"> <li>• The state of the Red LED of the respective RG..N is ON with a specific flashing rate</li> <li>• Alarm flag (<b>AL1SF</b>), Comms error flag (<b>CMERF</b>) or internal error flag (<b>INERF</b>) in the RG..N status register (<b>EDGSR</b>) is set</li> <li>• Any of the flags in the Alarm 1 status register (<b>AL1SR</b>) of the respective RG..N is set</li> </ul> <p>Please refer to the NRG User Manual for further information</p>	
<p><b>Alarm types</b></p>	<p><b>No. of flashes</b></p>	<p><b>Description of fault</b></p>
	100% ON	<p><b>Over-temperature:</b></p> <ul style="list-style-type: none"> <li>- The RG..N is operating outside its operating range causing the junction to overheat</li> <li>- The output of the RG..N is switched OFF (irrespective of the control voltage presence) to prevent damage to the RG..N</li> <li>- The alarm is restored automatically after the cooling-off period</li> </ul>
	2	<p><b>Mains loss:</b></p> <p>Voltage and current signals are absent. The cause is a mains loss (with REF terminal connected)</p>
	3	<p><b>Load loss / SSR open circuit:</b></p> <p>Load is not switching ON when control signal is present. The cause is either a load loss or a RG..N open circuit condition</p>
	4	<p><b>SSR short circuit:</b></p> <p>Current flowing through the RG..N output in the absence of a control signal</p>
	5	<p><b>Frequency Out of Range:</b></p> <ul style="list-style-type: none"> <li>- The RG..N is operated outside the range set by the Over Frequency and Under Frequency Limit registers (OFLMR and UFLMR).</li> <li>- Default range is 44 – 66 Hz</li> <li>- The RG..N will not stop operating if the frequency measured is out of the set range. The alarm is restored automatically when the frequency is back within the expected range</li> </ul>
	6	<p><b>Current Out of Range:</b></p> <ul style="list-style-type: none"> <li>- The RG..N is operated outside the range set by the Over Current and Under Current Limit registers (OCLMR and UCLMR).</li> <li>- Default range is 0 – max. rating of the respective RG..N</li> <li>- The RG..N will not stop operating if the current measured is out of the set range. The alarm is restored automatically when the current is back within the expected range</li> </ul>
	7	<p><b>Voltage Out of Range:</b></p> <ul style="list-style-type: none"> <li>- The RG..N is operated outside the range set by the Over Voltage and Under Voltage Limit registers (OVLMR and UVLMR).</li> <li>- Default range is 0 – 660 V</li> <li>- The RG..N will not stop operating if the voltage measured is out of the set range. The alarm is restored automatically when the voltage is back within the expected range</li> </ul>
	8	<p><b>Communication error (BUS):</b></p> <p>An error in the communication link (internal bus) between the NRG and RG..Ns</p>
	9	<p><b>Internal error:</b></p> <p>Bus supply out of range, hardware damage or detection of abnormal conditions</p>
<p><b>Flashing rate</b></p>		

**Short circuit protection**

**Protection Co-ordination, Type 1 vs Type 2:**

Type 1 protection implies that after a short circuit, the device under test will no longer be in a functioning state. In Type 2 co-ordination the device under test will still be functional after the short circuit. In both cases, however the short circuit has to be interrupted. The fuse between enclosure and supply shall not open. The door or cover of the enclosure shall not be blown open. There shall be no damage to conductors or terminals and the conductors shall not separate from terminals. there shall be no breakage or cracking of insulating bases to the extent that the integrity of the mounting of live parts is impaired. Discharge of parts or any risk of fire shall not occur.

The product variants listed in the table hereunder are suitable for use on a circuit capable of delivering not more than 100,000A rms Symmetrical Amperes, 600 Volts maximum when protected by fuses. Tests at 100,000A were performed with Class J fuses, fast acting; please refer to the table below for maximum allowed ampere rating of the fuse. Use fuses only.

Tests with Class J fuses are representative of Class CC fuses.

Protection co-ordination Type 1 according to UL 508				
Part No.	Prospective short circuit current [kArms]	Max fuse size [A]	Class	Voltage [VAC]
RGS..50, RGC..25	100	30	J or CC	max. 600
RGS..92, RGC..32, RGC..42, RGC..62	100	80	J	max. 600

Protection co-ordination Type 2 with semiconductor fuses						
Part number	Prospective short circuit current [kArms]	Mersen (Ferraz Shawmut)		Siba		Voltage [VAC]
		Max fuse size [A]	Part number	Max fuse size [A]	Part number	
RGC..25	10	40	6.9xx CP GRC 22x58 /40	32	50 142 06.32	max. 600
	100	40	6.9xx CP GRC 22x58 /40	32	50 142 06.32	max. 600
RGC..32 RGC..42	10	63	6.9xx CP URC 14x51 /63	80	50 194 20.80	max. 600
	10	70	A70QS70-4	80	50 194 20.80	max. 600
	100	63	6.9xx CP URC 14x51 /63	80	50 194 20.80	max. 600
	100	70	A70QS70-4	80	50 194 20.80	max. 600
RGC..62	10	100	6.9xx CP GRC 22x58 /100	100	50 194 20.100	max. 600
	10	100	A70QS100-4	100	50 194 20.100	max. 600
	100	100	6.621 CP URGD 27x60 /100	100	50 194 20.100	max. 600
	100	100	A70QS100-4	100	50 194 20.100	max. 600
RGS..50	10	80	6.621 CP URQ 27x60 /80	50	50 142 06.50	max. 660
	10	70	A70QS70-4	50	50 142 06.50	max. 660
	100	80	6.621 CP URQ 27x60 /80	50	50 142 06.50	max. 660
	100	70	A70QS70-4	50	50 142 06.50	max. 660
RGS..92	10	125	6.621 CP URD 22x58 /125	125	50 194 20.125	max. 660
	10	125	A70QS125-4	125	50 194 20.125	max. 660
	100	125	6.621 CP URD 22x58 /125	125	50 194 20.125	max. 660
	100	125	A70QS125-4	125	50 194 20.125	max. 660

Protection co-ordination Type 2 with Minature Circuit Breakers (M.C.B.s)				
Solid State Relay type	ABB Model no. for Z - type M. C. B. (rated current)	ABB Model no. for B - type M. C. B. (rated current)	Wire cross sectional area [mm <sup>2</sup> ]	Minimum length of Cu wire conductor [m] <sup>5</sup>
RGS..50, RGC..25 (1800 A <sup>2</sup> s)	1-pole S201 - Z10 (10 A)	S201-B4 (4 A)	1.0	7.6
			1.5	11.4
			2.5	19.0
	S201 - Z16 (16 A)	S201-B6 (6 A)	1.0	5.2
			1.5	7.8
			2.5	13.0
			4.0	20.8
	S201 - Z20 (20 A)	S201-B10 (10 A)	1.5	12.6
			2.5	21.0
	S201 - Z25 (25 A)	S201-B13 (13 A)	2.5	25.0
4.0			40.0	
2-pole S202 - Z25 (25 A)	S202-B13 (13 A)	2.5	19.0	
		4.0	30.4	
RGS..92, RGC..32, RGC..42, RGC..62 (18000 A <sup>2</sup> s)	1-pole S201 - Z32 (32 A)	S201-B16 (16 A)	2.5	3.0
			4.0	4.8
			6.0	7.2
	S201 - Z50 (50 A)	S201-B25 (25 A)	4.0	4.8
			6.0	7.2
			10.0	12.0
			16.0	19.2
	S201 - Z63 (63 A)	S201-B32 (32 A)	6.0	7.2
			10.0	12.0
			16.0	19.2

#### 5. Between MCB and Load (including return path which goes back to the mains)

Note: A prospective current of 6 kA and a 230 / 400 V power supply is assumed for the above suggested specifications. For cables with different cross section than those mentioned above please consult Carlo Gavazzi's Technical Support Group.



## Dimensions

### RGS...KEN

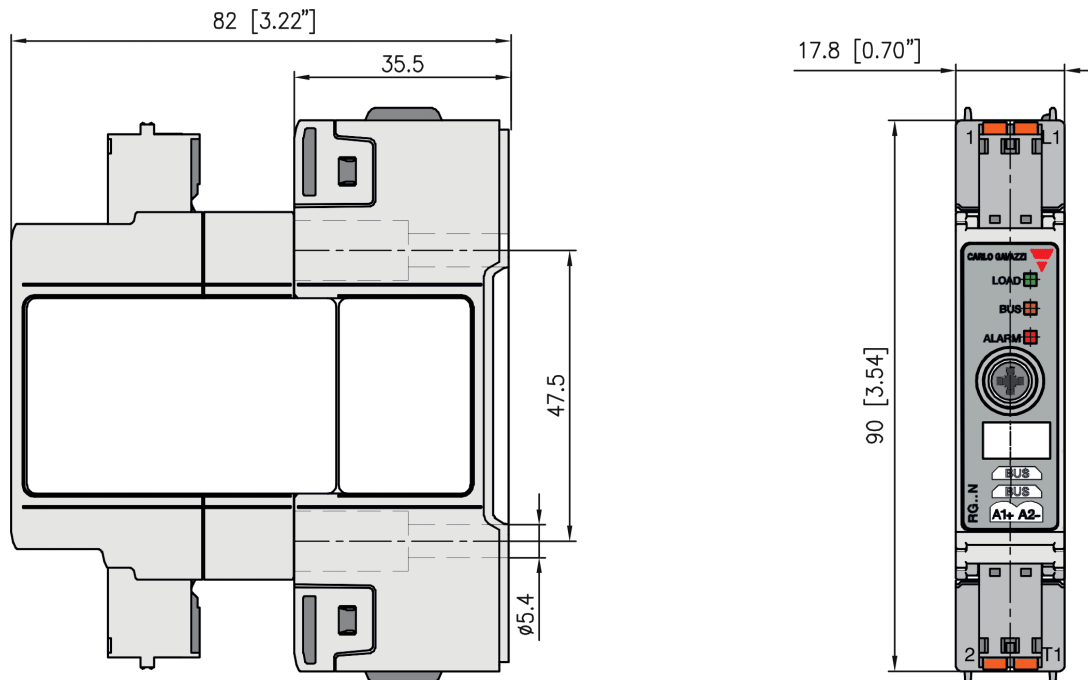

### RGS...GEN

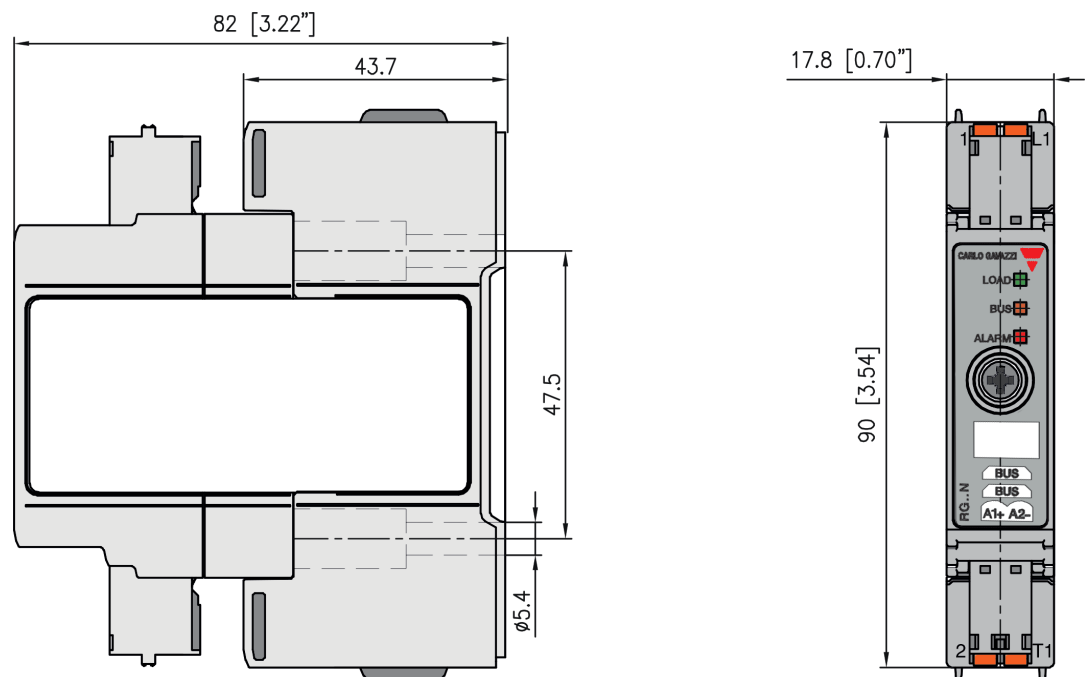

Housing width tolerance +0.5mm, -0mm as per DIN 43880.  
 All other tolerances +/- 0.5mm.  
 Dimensions in mm.

## RGC...25KEN, RGC...32KEN

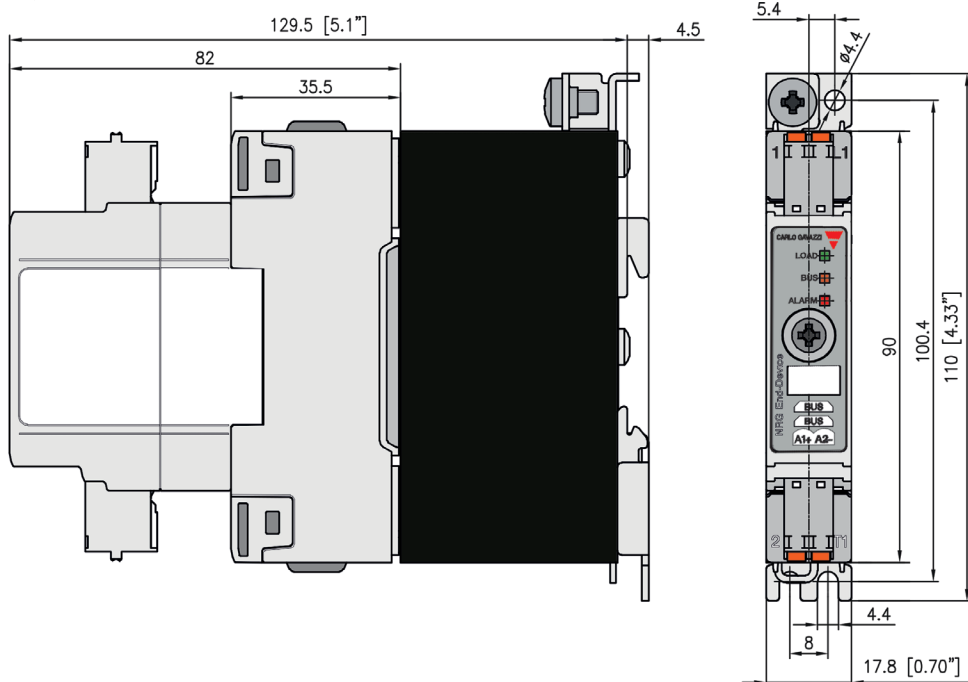

## RGC...32GEN

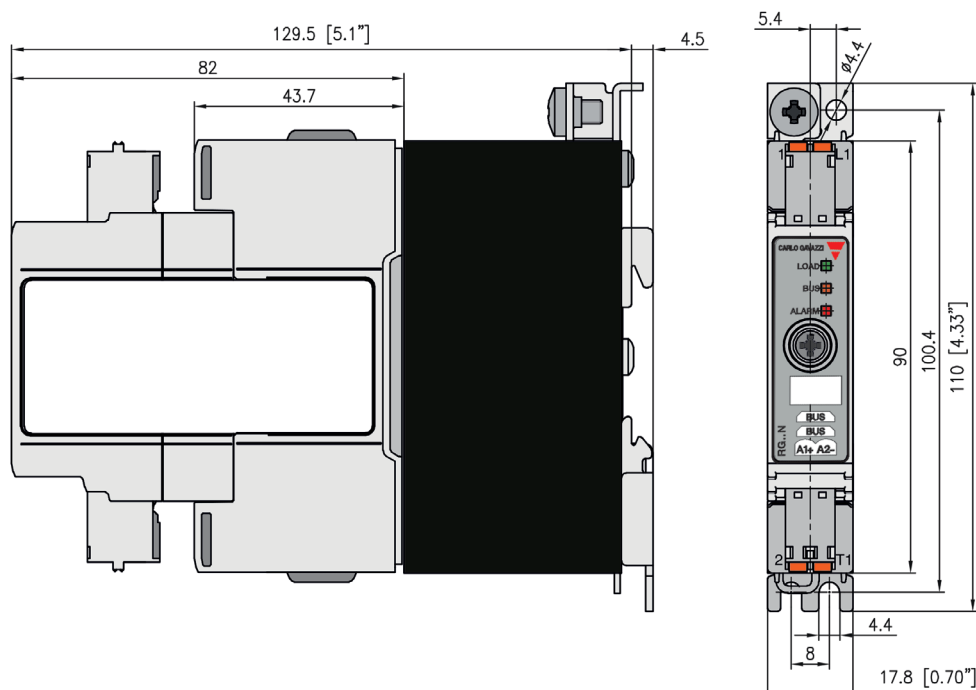

Housing width tolerance +0.5mm, -0mm as per DIN 43880.  
 All other tolerances +/- 0.5mm.  
 Dimensions in mm.

## RGC...42GEN

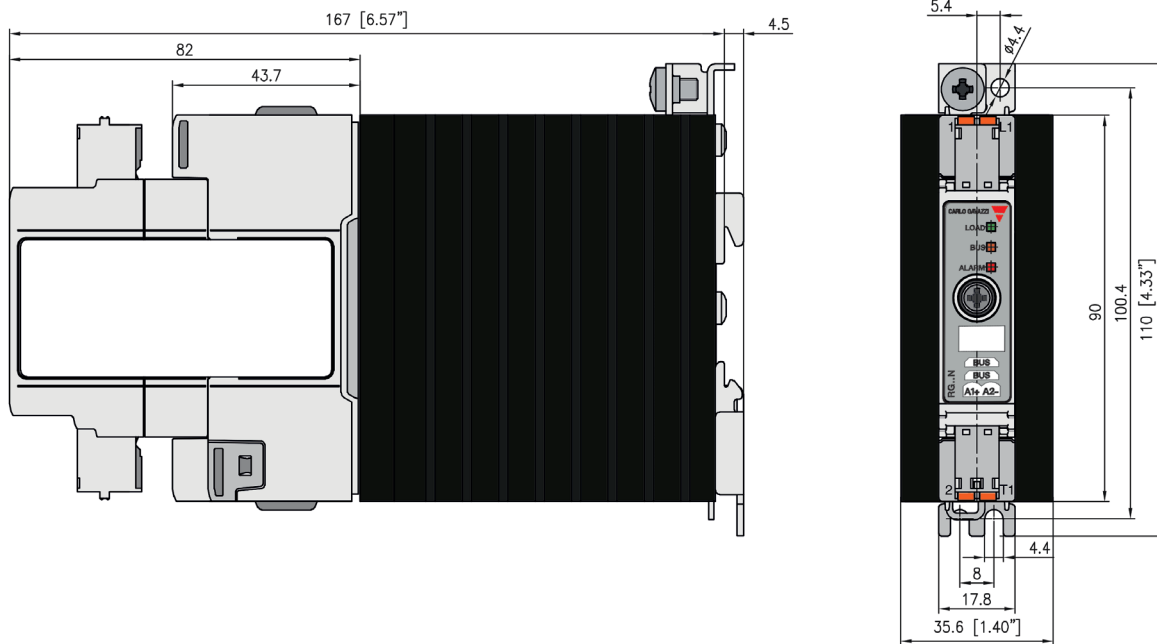

## RGC...62GEN

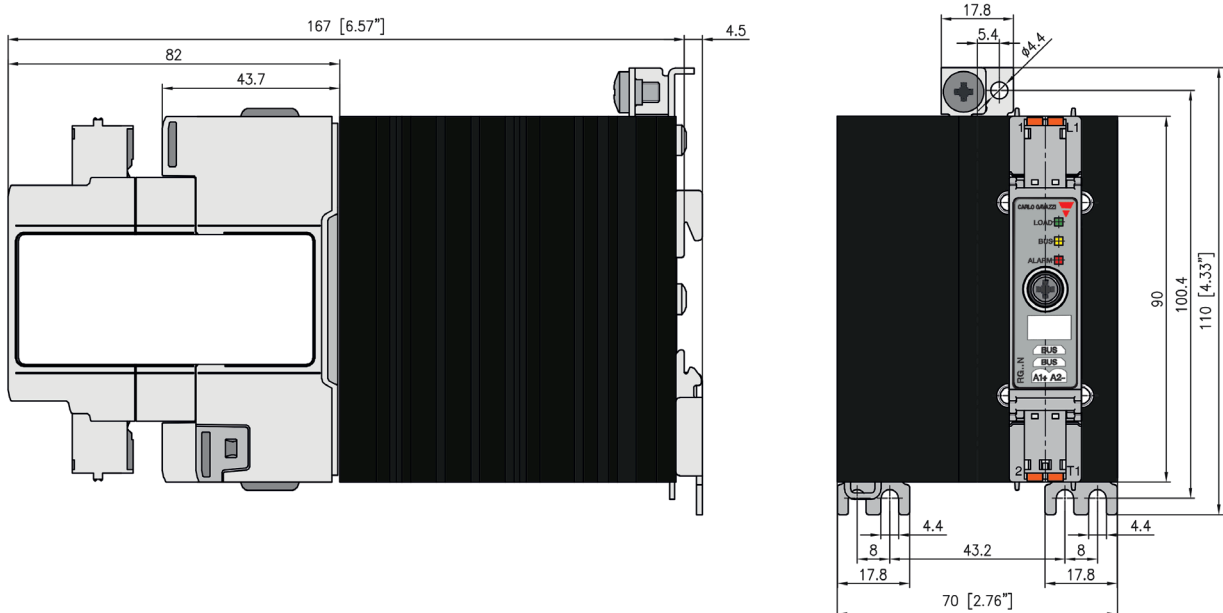

Housing width tolerance +0.5mm, -0mm as per DIN 43880.  
 All other tolerances +/- 0.5mm.  
 Dimensions in mm.

▶ Load connection diagram

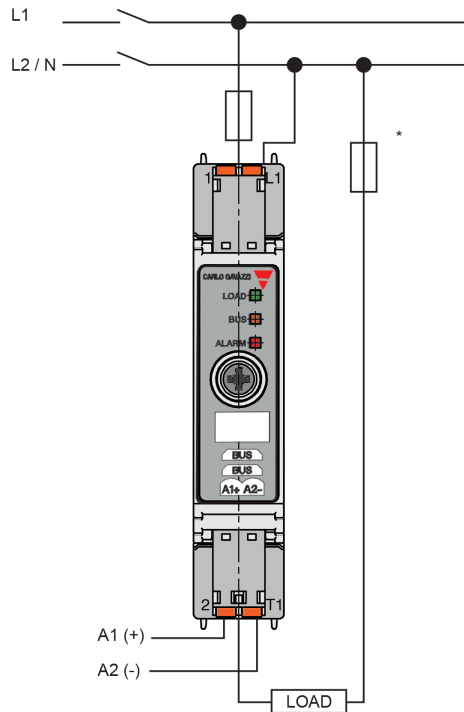

\*depends on system requirements

## BUS connection diagram

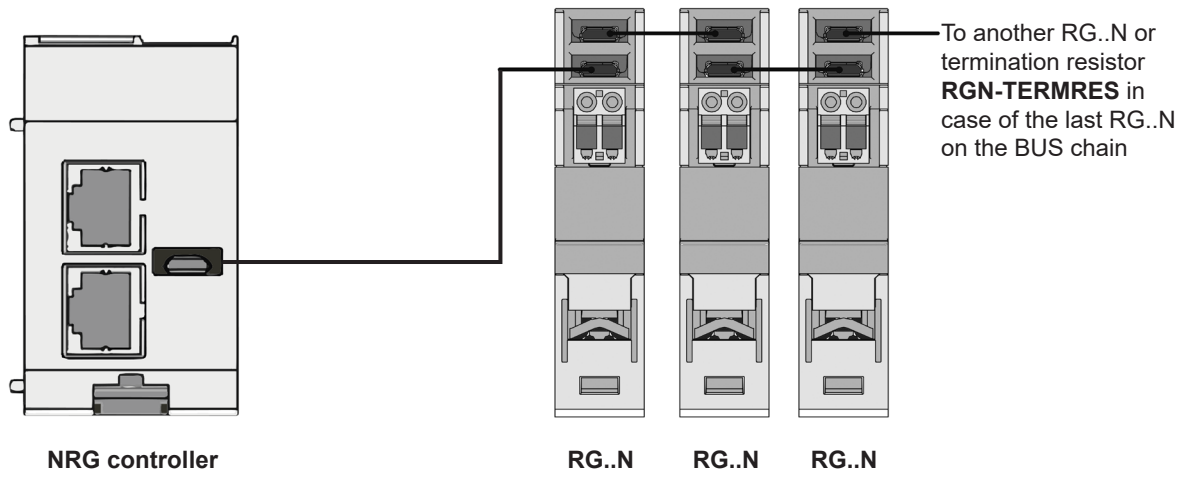

## Functional diagram

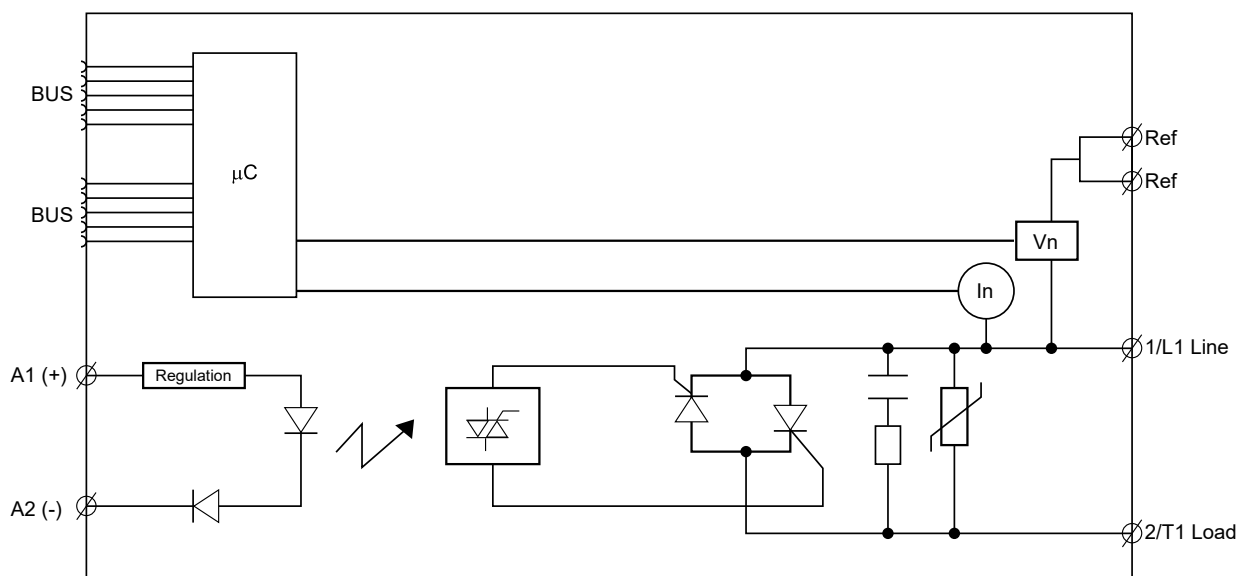

**Mounting**

**RGC**

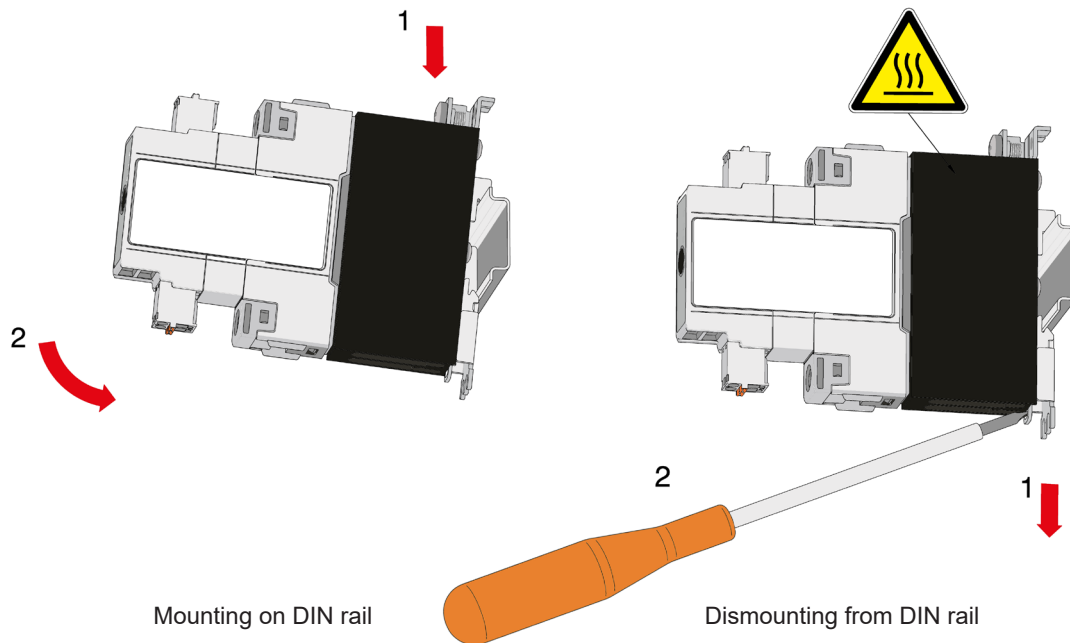

**RGS**

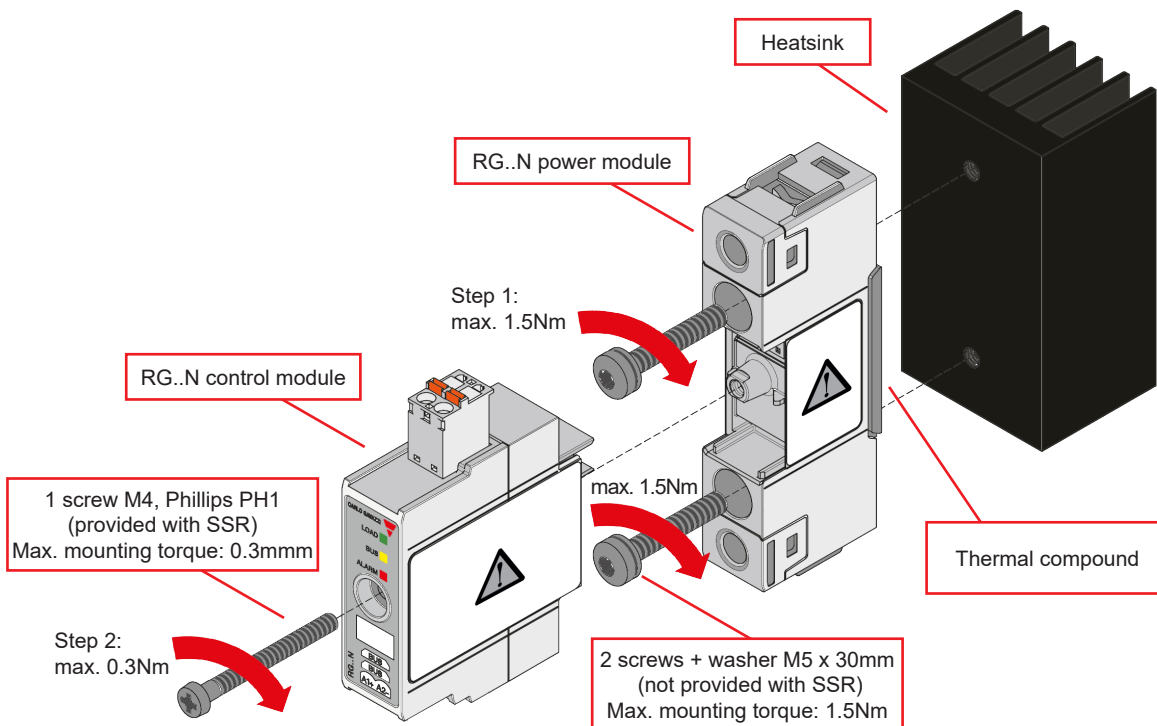

- Step 1: Mount RG..N power module to Heatsink
- Step 2: Mount RG..N control module on RG..N power module



Make sure that the sin code marked on the control unit matches the sin code of the power unit before mounting

Installation

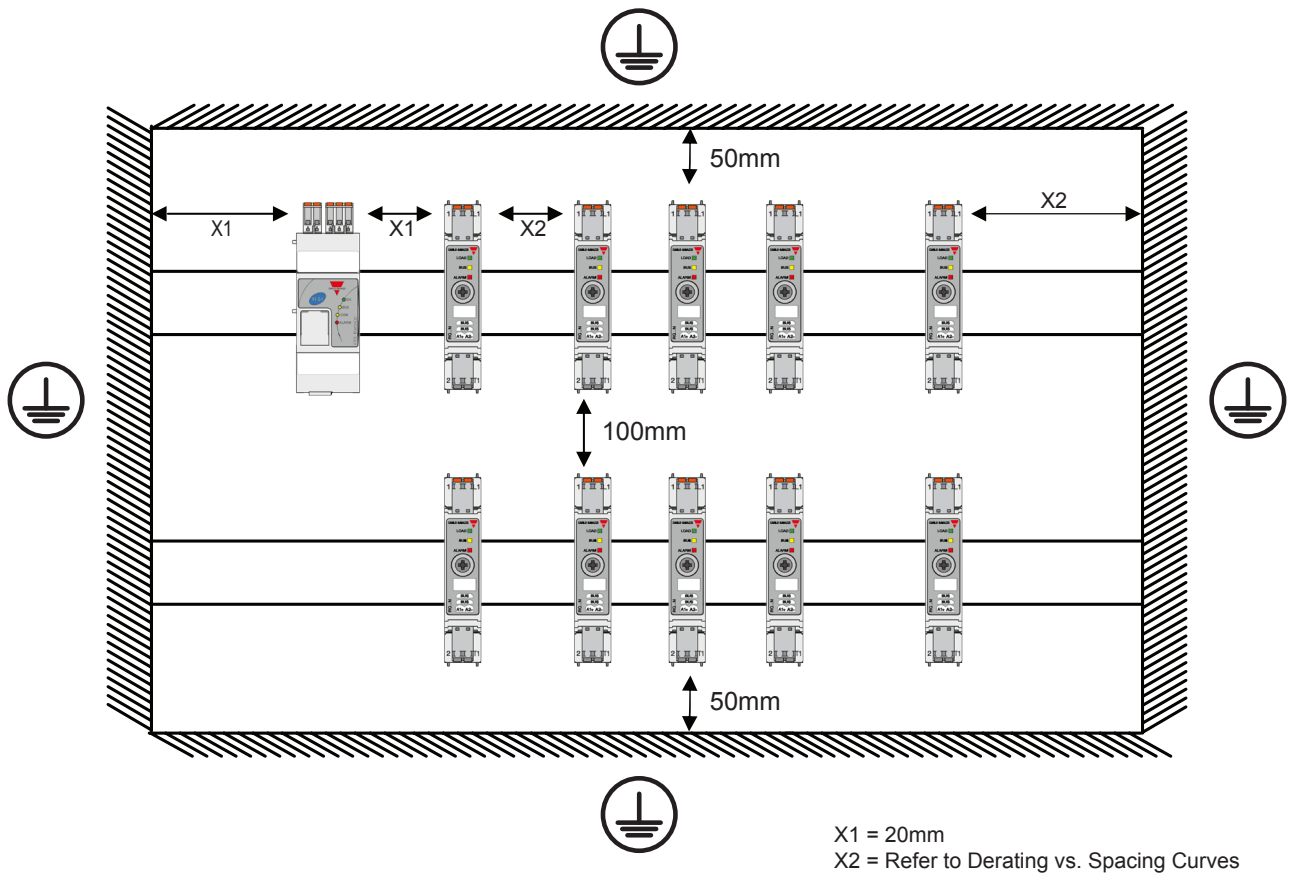

## Connection specifications

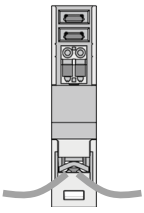
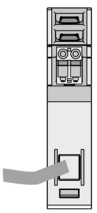
Power connection			
<b>Terminal</b>	1/L1, 2/T1		
<b>Conductors</b>	Use 75°C copper (Cu) conductors		
	RG..KEN	RG..GEN	
			
<b>Stripping length</b>	12 mm	11 mm	
<b>Connection type</b>	M4 screw with captivated washer	M5 screw with box clamp	
<b>Rigid (solid &amp; stranded) UL/CSA rated data</b>	2x 2.5 – 6.0 mm <sup>2</sup> 2x 14 – 10 AWG	1x 2.5 – 6.0 mm <sup>2</sup> 1x 14 – 10 AWG	1x 2.5 – 25.0 mm <sup>2</sup> 1x 14 – 3 AWG
<b>Flexible with end sleeve</b>	2x 1.0 – 2.5 mm <sup>2</sup> 2x 2.5 – 4.0 mm <sup>2</sup> 2x 18 – 14 AWG 2x 14 – 12 AWG	1x 1.0 – 4.0 mm <sup>2</sup> 1x 18 – 12 AWG	1x 2.5 – 16.0 mm <sup>2</sup> 1x 14 – 6 AWG
<b>Flexible without end sleeve</b>	2x 1.0 – 2.5 mm <sup>2</sup> 2x 2.5 – 6.0 mm <sup>2</sup> 2x 18 – 14 AWG 2x 14 – 10 AWG	1x 1.0 – 6.0 mm <sup>2</sup> 1x 18 – 10 AWG	1x 4.0 – 25.0 mm <sup>2</sup> 1x 12 – 3 AWG
<b>Torque specifications</b>	Posidrive bit 2 UL: 2.0 Nm (17.7 lb-in) IEC: 1.5 – 2.0 Nm (13.3 – 17.7 lb-in)	Posidrive bit 2 UL: 2.5 Nm (22 lb-in) IEC: 2.5 – 3.0 Nm (22 – 26.6 lb-in)	
<b>Aperture for termination lug (fork or ring)</b>	12.3 mm	n/a	
<b>Protective Earth (PE) connection</b>	M5, 1.5 Nm (13.3 lb-in) M5 PE screw is not provided with the solid state relay. PE connection is required when product is intended to be used in Class 1 applications according to EN/IEC 61140		

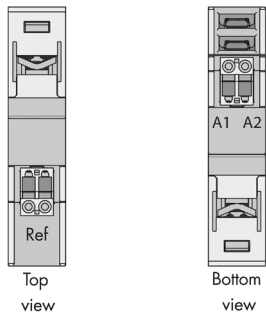

Control & Ref connection	
Terminals	Ref (x2 poles internally shorted on RG..N) A1+, A2-
	 <p>Top view</p> <p>Bottom view</p>
Conductors	Use 60/75°C copper (Cu) conductors
Stripping length	11 – 12 mm
Connection type	Spring plug, pitch 5.08 mm
Rigid (solid & stranded) UL/CSA rated data	0.2 – 2.5 mm <sup>2</sup> , 26 – 12 AWG
Flexible with end sleeve	0.25 – 2.5 mm <sup>2</sup>
Flexible without end sleeve	0.25 – 2.5 mm <sup>2</sup>
Flexible with end sleeve using TWIN ferrules	0.5 – 1.0 mm <sup>2</sup>
Ref internal short current handling capability	< 2 AAC

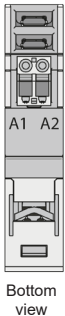
BUS connection	
Terminal	BUS (x2)
	 <p>BUS</p> <p>BUS</p> <p>A1 A2</p> <p>Bottom view</p>
Type	RCRGN-xxx (where xxx refers to the length in cm) 5-way terminated with micro USB connector  Cable lengths available: 10 cm <b>RCRGN-010-2</b> 25 cm <b>RCRGN-025-2</b> 75 cm <b>RCRGN-075-2</b> 150 cm <b>RCRGN-150-2</b> 350 cm <b>RCRGN-350-2</b> 500 cm <b>RCRGN-500-2</b>
Conductors	+24 V, GND, Data, Data, Auto- addressing line



# RCRGN..

## NRG internal BUS cable



### Main features

- Cables available at various lengths to provide the internal BUS of the NRG system
- Cables terminated at both ends with a microUSB plug
- Connects the NRG controller to the RG..N solid state relay and respective RG..N solid state relays

### Description

The **RCRGN** cables are proprietary cables that must be used with the NRG system for the internal BUS. These cables connect the NRG controller to the RG..N solid state relays and respective RG..N solid state relays.

The RCRGN... are 5-way cables carrying the communication, supply and autocofiguration lines. By means of autoconfiguration, the RG..Ns are assigned a unique ID based on the physical location and hence internal BUS wiring sequence when an autoconfiguration command is sent to the RG..Ns.

### Carlo Gavazzi compatible components

Description	Component code	Notes
<b>NRG Controller</b>	NRGC..	<ul style="list-style-type: none"> <li>• <b>NRGC</b>: NRG controller with Modbus communication.</li> <li>• <b>NRGC-PN</b>: NRG controller with PROFINET communication.</li> <li>• <b>NRGC-EIP</b>: NRG controller with EtherNet/IP communication.</li> <li>• <b>NRGC-ECAT</b>: NRG controller with EtherCAT communication.</li> <li>• <b>NRGC-MBTCP</b>: NRG controller with Modbus TCP communication.</li> </ul> 1x RGN-TERMRES is included in the NRGC.. packaging. The RGN-TERMRES is to be mounted on the last RG..N on the bus chain.
<b>Solid state relays</b>	RG..N	NRG solid state relays

### Order code

RCRGN -  - 2

Enter the code entering the corresponding option instead of

Code	Option	Description	Notes	
R	-	Cables		
C	-			
R	-			
G	-		Suitable for the NRG system	
N	-			
<input type="checkbox"/>	010	10 cm cable length	packed x 4 pcs.	
	025	25 cm cable length	packed x 1 pc.	
	075	75 cm cable length	packed x 1 pc.	
	150	150 cm cable length	packed x 1 pc.	
	350	350 cm cable length	packed x 1 pc.	
	500	500 cm cable length	packed x 1 pc.	
2	-	Terminated at the both ends with a microUSB connector		



COPYRIGHT ©2022  
Content subject to change.  
Download the PDF: <https://gavazziautomation.com>