

RG..CM..N



RG 1-phase solid state relays with a communications interface

Communication interface for control of solid state relay and real time monitoring



RGC..CM..N

RGS..CM..N

Benefits

- **Communications interface.** Reduced wiring and I/O modules. Solid state relay can exchange data with the system controller via this interface.
- **Reduced maintenance costs and downtime.** Use of real-time data for prevention of machine stoppages during operation.
- **Good quality products and low scrap rates.** Real-time monitoring allows timely decisions for better machine and process management.
- **Reduced efforts in troubleshooting.** Distinguished faults to facilitate and reduce troubleshooting time.
- **Configurable.** The switching mode of the RG..CM..N can be selected to either ON/OFF switching or power control.
- **Fast installation and set-up.** The solid state relays on the BUS are automatically configured for fast set-up and prevention of incorrect settings.
- **Compact dimensions.** Slimline RG series for a minimum product width of 17.8 mm, 1x DIN, up to 37 AAC at 40°C.

Description

The **RG..N** solid state relays are the switching components in the NRG BUS chain.

Similar to the RG..D..N, the **RG..CM..N** has integrated monitoring and a communication interface to provide variables and diagnostic information in real-time. The variables that can be read out are current, voltage, frequency, power, energy consumption, load and SSR running hours. The status of each **RG..CM..N** is accessible. Faults are specifically indicated to facilitate troubleshooting.

With the **RG..CM..N** solid state relays it is additionally possible to control the outputs of the solid state relays via the communication interface. There are two variants, the RGx1A..CM..N is the zero cross relay including various switching modes such as ON/OFF switching, Burst, Distributed full cycle and Advanced Full cycle modes. The RGx1P..CM..N is the proportional control variant which on top of the aforementioned switching modes includes also phase angle switching and soft starting features.

The **RG..N** cannot interface directly with the system controller (PLC) but needs to be configured in an **NRG BUS chain** (as explained further on). 1 **NRG BUS chain** can handle up to 32 **RG..CM..Ns**. The first **RG..N** in the BUS chain is connected to the NRG controller, whilst the last **RG..N** in the BUS chain has to be terminated with a BUS terminator provided with the NRG controller.

The **RGC..N** (with integrated heatsink) output ratings go up to 660 VAC, 65 A whilst the **RGS..N** (without heatsink) output ratings go up to 660 VAC, 90 A. Specifications are noted at 25°C unless otherwise specified.

Applications

Any heating application where reliable and precise maintenance of temperatures is crucial to the quality of the end product. Typical applications include plastic machinery such as injection machines, extrusion machines and PET blow moulding machines, packaging machinery, sterilisation machinery, drying tunnels and semiconductor manufacturing equipment.

Main function

- RGx1A..CM..N: 1 phase, AC zero cross solid state relays up to 660VAC, 90AAC
- RGx1P..CM..N: 1 phase, AC proportional control solid state relays up to 660VAC, 90AAC
- RGx1A..CM..N switching modes: ON/OFF, Burst, Distributed full cycle, Advanced full cycle, External control (via a DC control voltage)
- RGx1P..CM..N switching modes: Phase angle, ON/OFF, Burst, Distributed full cycle and Advanced full cycle. Soft starting and Voltage compensation available with all switching modes
- Measurements and diagnostics accessible through the communication interface

The NRG system

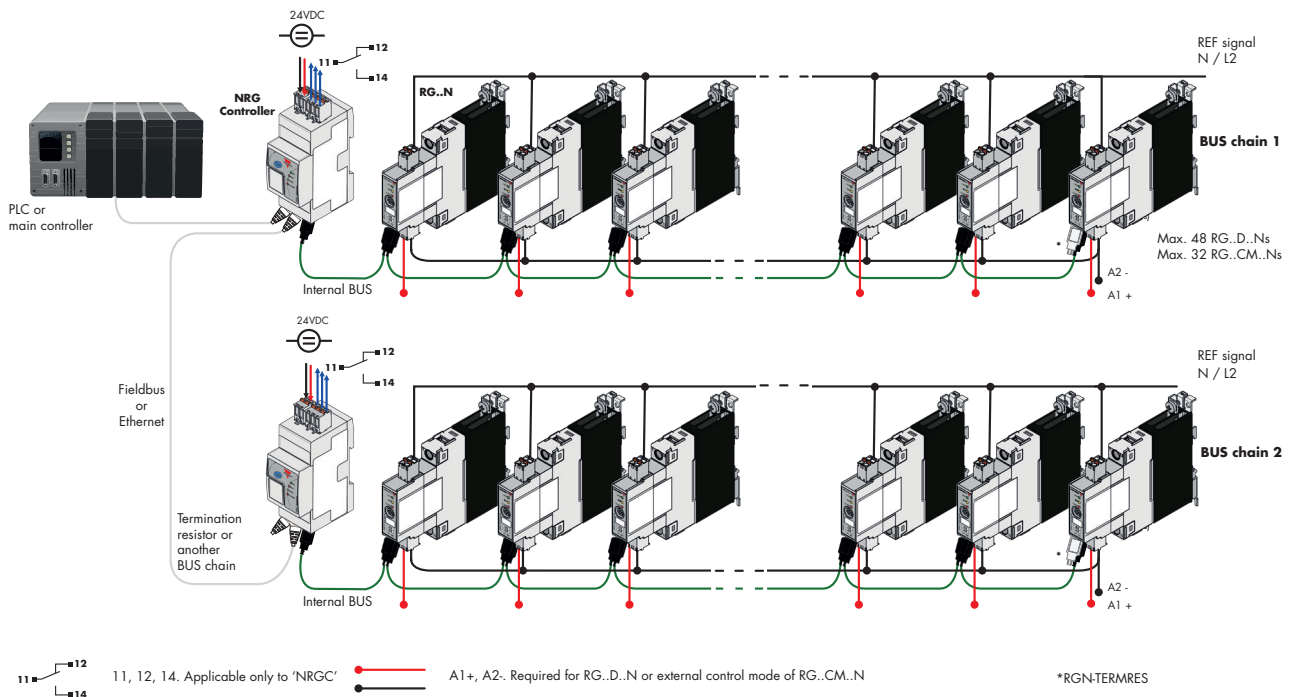

System Overview

The NRG is a system consisting of one or more BUS chains that enable communication between the field devices (such as the solid state relays) and the control devices (such as the machine controller or PLC).

Each **NRG BUS** chain consists of the following 3 components:

- the NRG controller
- the NRG solid state relay(s)
- the NRG internal BUS cables

The **NRG controller** is the interface to the machine controller. It acts as the master of the BUS chain when performing specific actions on the respective BUS chain, and acts as a gateway for the communication between the PLC and the RG..N solid state relays. It is not possible to operate the NRG system without the NRG controller.

The NRG controllers available are:

- **NRGC**

The NRGC is a NRG controller with a Modbus RTU interface over RS485. The NRGC is addressed via the assigned Modbus ID (from 1-247). In a NRG system operating on Modbus it is possible to have 247 NRG BUS chains.

- **NRGC-PN**

NRGC-PN is a NRG controller with a PROFINET communication interface. The NRGC-PN is identified by a unique MAC address which is printed on the facade of the product. The GSD file can be downloaded from www.gavazziautomation.com

- **NRGC-EIP**

NRGC-EIP is a NRG controller with an EtherNet/IP communication interface. The IP address is provided automatically via a DHCP server. The EDS file can be downloaded from www.gavazziautomation.com

- **NRGC-ECAT**

NRGC-ECAT is a NRG controller with an EtherCAT communication interface. The ESI file can be downloaded from www.gavazziautomation.com

- **NRGC-MBTCP**

NRGC-MBTCP is a NRG controller with a Modbus TCP communication interface.

System Overview (continued)

The **NRG solid state relay** is the switching component in the NRG system. Each **RG..N** integrates a communication interface to exchange data with the machine controller (or PLC). The available RG..Ns that can be used in an NRG system are:

- **RG..D..N**

The RG..D..N are solid state relays for use in an NRG system having the communication interface only for real time monitoring. Control of the RG..N is done via a DC control voltage. It is possible to have maximum 48 **RG..D..Ns** in one NRG BUS chain.

- **RG..CM..N**

The RG..CM..N are solid state relays for use in an NRG system having a communication interface for control of the RG..N through the BUS and for real time monitoring. It is possible to have a maximum of 32 RG..CM..N in one NRG bus chain. There are two variants of the RG..CM..N:

RGx1A..CM..N - the solid state relay with zero cross switching

RGx1P..CM..N - the solid state relay with proportional switching.

For a review of the features available in both variants refer to the table below:

Feature	RGx1A..CM..N	RGx1P..CM..N
External control	●	-
ON / OFF switching	●	●
Burst switching	●	●
Distributed full cycle switching	●	●
Advanced full cycle switching	●	●
Phase angle	-	●
Soft start with time mode	-	●
Soft start with current limit mode	-	●
Voltage compensation	-	●
Monitoring of system parameters	●	●
SSR diagnostics	●	●
Load diagnostics	●	●
Overtemperature protection	●	●

It is not possible to mix RG..D..N and RG..CM..N in the same BUS chain.

The **NRG internal BUS cables** are proprietary cables that connect the NRG controller to the first RG..N in the NRG BUS chain and respective RG..Ns on the BUS. The internal BUS terminator, provided in the same package with the NRG controller, shall be plugged to the last RG..N in the NRG BUS chain.

NRG system required components

Description	Component code	Notes
Solid state relays	RG..N	NRG solid state relays
NRG controller	NRGC..	<ul style="list-style-type: none"> • NRGC: NRG controller with Modbus communication. • NRGC-PN: NRG controller with PROFINET communication. • NRGC-EIP: NRG controller with EtherNet/IP communication. • NRGC-ECAT: NRG controller with EtherCAT communication. • NRGC-MBTCP: NRG controller with Modbus TCP communication. 1x RGN-TERMRES is included in the NRGC.. packaging. The RGN-TERMRES is to be mounted on the last RG..N on the bus chain.
NRG internal BUS cables	RCRGN-xxx	Proprietary cables terminated at both ends with a micro USB connector



▶ List of contents

RG..CM..N	
References	5
Structure	8
Features.....	9
General data	9
Performance	9
RGS output specifications	9
RGC output specifications	10
Input specifications	10
Input current vs. input voltage.....	10
Internal bus	11
Output power dissipation	11
RGS heatsink selection	12
RGS thermal data	12
RGC current derating.....	13
RGC derating vs. spacing.....	13
Compatibility and conformance	15
Filter connection diagram	16
Filtering	16
Environmental specifications	17
Switching modes.....	18
Measurements	21
LED indicators	21
Alarm management	22
Short circuit protection	23
Dimensions	25
Load connection diagram	28
BUS connection diagram	29
Functional diagram	29
Mounting	30
Installation.....	31
Connection specifications	32
RCRGN	34

References

Order code

 RG 1A60CM EN

Enter the code entering the corresponding option instead of

Code	Option	Description	Notes
R	-	Solid State Relay (RG)	
G	-		
<input type="checkbox"/>	C	Version with integrated heatsink	
	S	Version without heatsink	
1	-	Number of poles	
<input type="checkbox"/>	A	Switching mode: zero cross	
	P	Switching mode: proportional	
60	-	Rated voltage: 600 VAC (42-660 VAC) 50/60 Hz	
CM	-	Control through the communication interface (ON/OFF or power control)	External control only applicable for RGx1A..CM..N
<input type="checkbox"/>	25	Rated current - 25 AAC	For RGC..only
	32	Rated current - 30 AAC, 37 AAC	For RGC..only
	42	Rated current - 43 AAC	For RGC..only
	62	Rated current - 65 AAC	For RGC..only
	50	Rated current - 50 AAC	For RGS..only
	92	Rated current - 90 AAC	For RGS..only
<input type="checkbox"/>	K	Screw connection for power terminals	
	G	Box clamp connection for power terminals	
E	-	Connection configuration	
N	-	For integration in an NRG system	
<input type="checkbox"/>	HT	Pre- attached thermal pad for RGS	Option

Selection guide - versions with integrated heatsink (RGC)

Rated voltage	Switching	Connection power	Rated operational current @ 40°C				
			25 AAC	30 AAC	37 AAC	43 AAC	65 AAC
			Product width				
			17.8 mm	17.8 mm	17.8 mm	35 mm	70 mm
600 VACrms	zero cross	Screw	RGC1A60CM25KEN	RGC1A60CM32KEN	-	-	-
		Box clamp	-	-	RGC1A60CM32GEN	RGC1A60CM42GEN	RGC1A60CM62GEN
	proportional	Screw	RGC1P60CM25KEN	RGC1P60CM32KEN	-	-	-
		Box clamp	-	-	RGC1P60CM32GEN	RGC1P60CM42GEN	RGC1P60CM62GEN

Selection guide - versions without heatsink (RGS)

Rated voltage	Switching	Connection power	Maximum rated operational current				
			50 AAC	90 AAC	-	-	-
			Product width				
		17.8 mm	17.8 mm	-	-	-	
600 VACrms	zero cross	Screw	RGS1A60CM50KEN	RGS1A60CM92KEN	-	-	-
		Box clamp	-	RGS1A60CM92GEN	-	-	-
	proportional	Screw	RGS1P60CM50KEN	RGS1P60CM92KEN	-	-	-
		Box clamp	-	RGS1P60CM92GEN	-	-	-







Selection guide - versions with attached thermal pad (RGS..HT)

Rated voltage	Switching	Connection power	Maximum rated operational current				
			90 AAC	-	-	-	-
			Product width				
		17.8 mm	-	-	-	-	
600 VACrms	zero cross	Box clamp	RGS1A60CM92GENHT	-	-	-	-
		Box clamp	RGS1P60CM92GENHT	-	-	-	-
	proportional	Screw	RGS1P60CM92KENHT	-	-	-	-

Carlo Gavazzi compatible components

Description	Component code	Notes
NRG controller	NRGC..	<ul style="list-style-type: none"> • NRGC: NRG controller with Modbus communication. • NRGC-PN: NRG controller with PROFINET communication. • NRGC-EIP: NRG controller with EtherNet/IP communication. • NRGC-ECAT: NRG controller with EtherCAT communication. • NRGC-MBTCP: NRG controller with Modbus TCP communication. 1x RGN-TERMRES is included in the NRGC.. packaging. The RGN-TERMRES is to be mounted on the last RG..N on the bus chain.
NRG Internal BUS cables	RCRGN-010-2	10cm cable terminated at both ends with a microUSB connector. Packed x4 pcs.
	RCRGN-025-2	25cm cable terminated at both ends with a microUSB connector. Packed x1 pc.
	RCRGN-075-2	75cm cable terminated at both ends with a microUSB connector. Packed x1 pc.
	RCRGN-150-2	150cm cable terminated at both ends with a microUSB connector. Packed x1 pc.
	RCRGN-350-2	350cm cable terminated at both ends with a microUSB connector. Packed x1 pc.
	RCRGN-500-2	500cm cable terminated at both ends with a microUSB connector. Packed x1 pc.
Termination resistor	RGN-TERMRES	Internal BUS chain terminator. 1 pc. is included in the NRGC.. packaging
Plugs	RGMREF	Spring plug labelled 'Ref'. Packed x10 pcs. 1 pc. included in the RG..N packaging
	RGM25	Spring plug labelled 'A1 A2'. Packed x10 pcs. (not applicable for RGx1P..CM..N)
Heatsinks	RHS...	Heatsinks for RGS models
Thermal pads	RGHT	Thermal pad mounted on RGS Pack of 10 thermal pads size 34.6 x 14mm

Further reading

Information	Where to find it	
NRG ModbusRTU user manual	https://gavazziautomation.com/images/PIM/MANUALS/ENG/SSR_UM_NRG.pdf	
NRG PROFINET user manual	https://gavazziautomation.com/images/PIM/MANUALS/ENG/SSR_UM_NRG_PN.pdf	
NRG EtherNet/IP user manual	https://gavazziautomation.com/images/PIM/MANUALS/ENG/SSR_UM_NRG_EIP.pdf	
NRG EtherCAT user manual	https://gavazziautomation.com/images/PIM/MANUALS/ENG/SSR_UM_NRG_ECATCHIP.pdf	
NRG Modbus TCP user manual	https://gavazziautomation.com/images/PIM/MANUALS/ENG/SSR_UM_NRG_MBTCP.pdf	
Datasheet NRG Controller with Modbus RTU	https://gavazziautomation.com/images/PIM/DATASHEET/ENG/SSR_NRGC.pdf	
Datasheet NRG Controller with PROFINET	https://gavazziautomation.com/images/PIM/DATASHEET/ENG/SSR_NRGC_PN.pdf	
Datasheet NRG Controller with EtherNet/IP	https://gavazziautomation.com/images/PIM/DATASHEET/ENG/SSR_NRGC_EIP.pdf	
Datasheet NRG Controller with EtherCAT	https://gavazziautomation.com/images/PIM/DATASHEET/ENG/SSR_NRGC_ECATCHIP.pdf	
Datasheet NRG Controller with Modbus TCP	https://gavazziautomation.com/images/PIM/DATASHEET/ENG/SSR_NRGC_MBTCP.pdf	
Datasheet RG..D..N solid state relay with only real-time monitoring via bus	https://gavazziautomation.com/images/PIM/DATASHEET/ENG/SSR_RG_D_N.pdf	
Online heatsink selector tool for RGS..N	http://gavazziautomation.com/nsc/HQ/EN/solid_state_relays	

Structure

RGC..CM..N

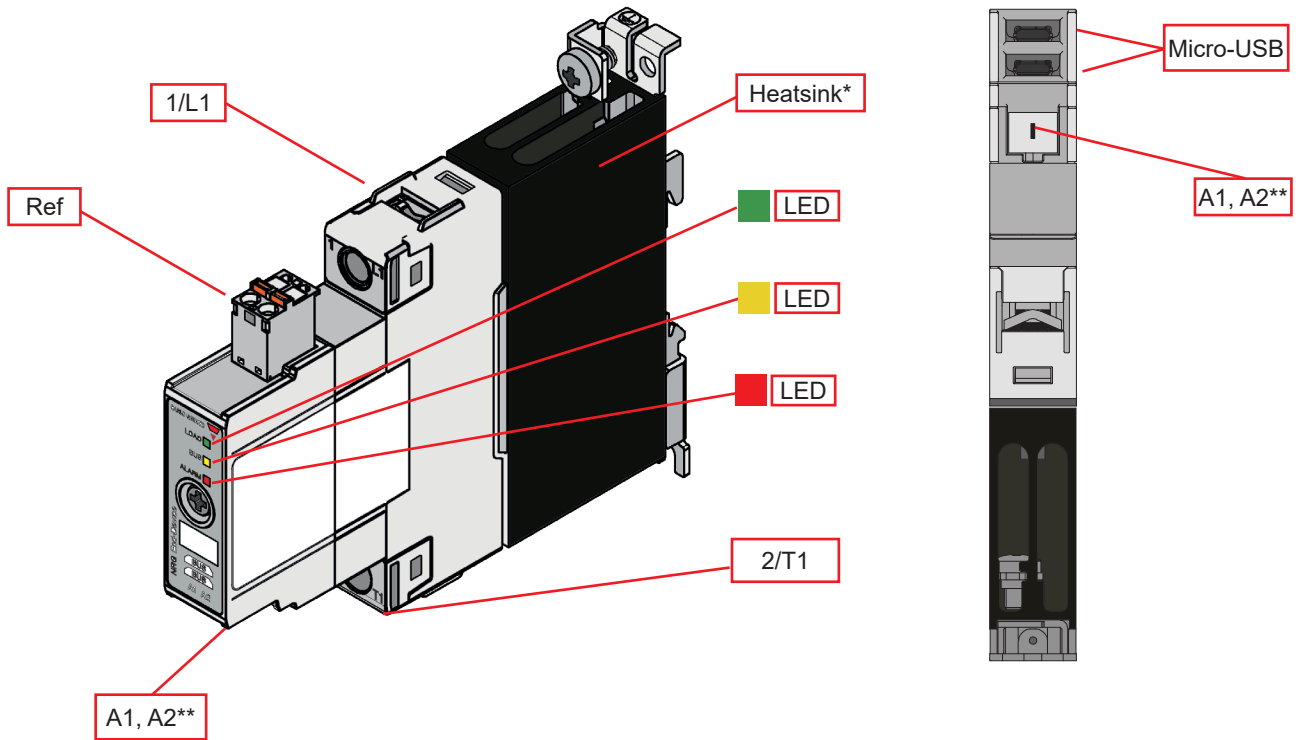

* integrated for RGC..N versions. RGS..N do not have an integrated heatsink
 ** optional for RGx1A..CM..N and not applicable for RGx1P..CM..N

Element	Component	Function
1/L1	Power connection	Mains connection
2/T1	Power connection	Load connection
Ref	Voltage reference connection	Reference signal (L2 or N) for voltage measurement 2-pole plug internally shorted to allow for looping
A1, A2	Control connection (optional)	Terminal for control voltage in case of external control. RGM25 plug is required (not applicable for RGx1P..CM..N)
Green LED	LOAD indicator	Indicates status of RG..N output
Yellow LED	BUS indicator	Indicates ongoing communication
Red LED	ALARM indicator	Indicates presence of an alarm condition
Micro-USB	Micro-USB ports for internal BUS	Interface for RCRGN cable connection for the internal BUS communications line
Heatsink	Integrated heatsink	Integrated for RGC..N versions RGS..N versions do not have an integrated heatsink

Features

General data

Material	PA66 or PA6 (UL94 V0), RAL7035 850°C, 750°C/2s according to GWIT and GWF1 requirements of EN 60335-1
Mounting	DIN rail (for RGC only) or panel
Touch Protection	IP20
Overvoltage Category	III, 6kV (1.2/50µs) rated impulse withstand voltage
Isolation	Input to Output: 2500 Vrms Input and Output to heatsink: 4000 Vrms
Weight	RGS..50: approx. 170 g RGS..92: approx. 170 g RGC..25: approx. 310 g RGC..32: approx. 310 g RGC..42: approx. 520 g RGC..62: approx. 1030 g
Compatibility	NRGC (NRG controller with Modbus RS485 interface) NRGC-PN (NRG controller with PROFINET interface) NRGC-EIP (NRG controller with EtherNet/IP interface) NRGC-ECAT (NRG Controller with EtherCAT interface) NRGC-MBTCP (NRG Controller with Modbus TCP interface)

Performance

RGS.. Output

	RGS..50..	RGS..92..
Operational voltage range, Ue	42 – 660 VAC	
Switching mode	RGS1A.. : zero cross switching RGS1P.. : proportional switching	
Max. operational current: AC-51 rating¹	50 AAC	90 AAC
Operational frequency range	50/60 Hz	
Blocking voltage	1200 Vp	
Power factor	> 0.9	
Output overvoltage protection	Integrated varistor across L1-T1	
Leakage current @ rated voltage	< 5 mAAC	
Minimum operational current	300 mAAC 1 AAC (Phase Angle)	500 mAAC 1 AAC (Phase Angle)
Maximum transient surge current (I_{TSM}), t=10 ms	600 Ap	1900 Ap
I²t for fusing (t=10ms), minimum	1800 A ² s	18000 A ² s
LED indication - LOAD	Green, ON when output is ON	
Critical dV/dt (@Tj init = 40°C)	1000 V/µs	
Transfer characteristics	Linear with output power	

1. Max. rated current with suitable heatsink. Refer to RGS heatsink selection tables.

▶ RGC.. Output

	RGC..25	RGC..32	RGC..42	RGC..62
Operational voltage range, Ue	42 - 660 VAC			
Switching mode	RGC1A.. : zero cross switching RGC1P.. : proportional switching			
Max. operational current: AC-51 rating @ 25°C ²	30 AAC	30 AAC KEN 43 AAC GEN	50 AAC	75 AAC
Max. operational current: AC-51 rating @ 40°C ²	25 AAC	30 AAC KEN 37 AAC GEN	43 AAC	65 AAC
Operational frequency range	50/60 Hz			
Blocking voltage	1200 Vp			
Power factor	> 0.9			
Output overvoltage protection	Integrated varistor across L1-T1			
Leakage current @ rated voltage	< 5 mAAC			
Minimum operational current	300 mAAC 1 AAC (Phase Angle)	500 mAAC 1 AAC (Phase Angle)		
Maximum transient surge current (I _{TSM}), t=10 ms	600 Ap	1900 Ap	1900 Ap	1900 Ap
I ² t for fusing (t=10ms), minimum	1800 A ² s	18000 A ² s	18000 A ² s	18000 A ² s
LED indication - LOAD	Green, ON when output is ON			
Critical dV/dt (@T _j init = 40°C)	1000 V/μs			
Transfer characteristics	Linear with output power			

2. Refer to RGC current derating curves for current ratings at different surrounding temperatures.

▶ Inputs (only for RGx1A..CM..N)

Control voltage range, U _c : A1, A2	4-32 VDC
Pick-up voltage	3.8 VDC
Drop-out voltage	1 VDC
Maximum reverse voltage	32 VDC
Maximum response time pick-up	½ cycle
Response time drop-out	½ cycle
Input current @ 40°C	See diagram below

Note: Control voltage via A1, A2 is only required for external control switching mode. For further information on other switching modes refer to 'Switching Modes' section.

▶ Input current vs input voltage (only for RGx1A..CM..N)

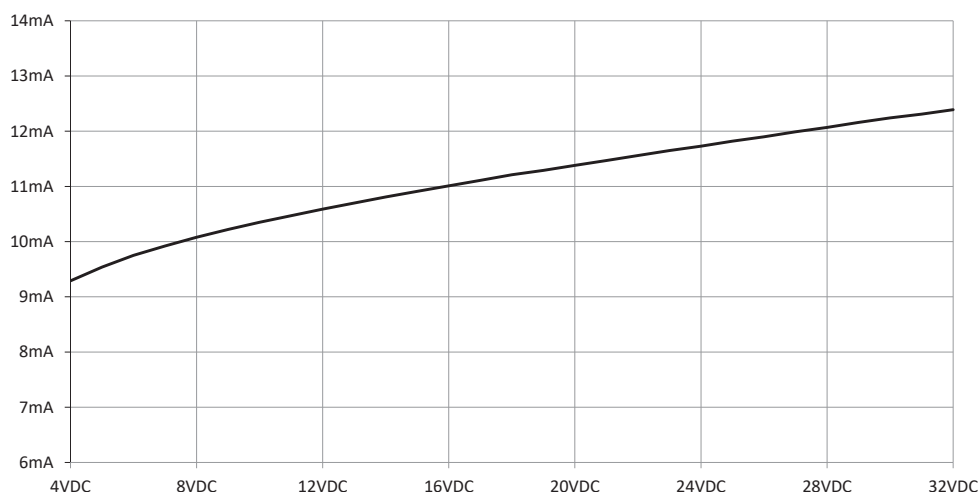

Internal bus

Supply voltage	Supplied through 2 wires of the RCRGN bus cable when connected to a powered NRG controller
BUS termination	RGN-TERMRES on last device in the bus chain
Max. no. of RG..Ns in a bus chain	32
LED indication - BUS	Yellow, ON during ongoing communication
ID for RG..Ns	Automatic through Autoconfiguring (Modbus), Auto-addressing (ethernet protocols), (refer to respective User Manuals for further details). Communication is only possible with RG..Ns that are configured correctly, i.e., they have a valid ID.

Output power dissipation

RGS..

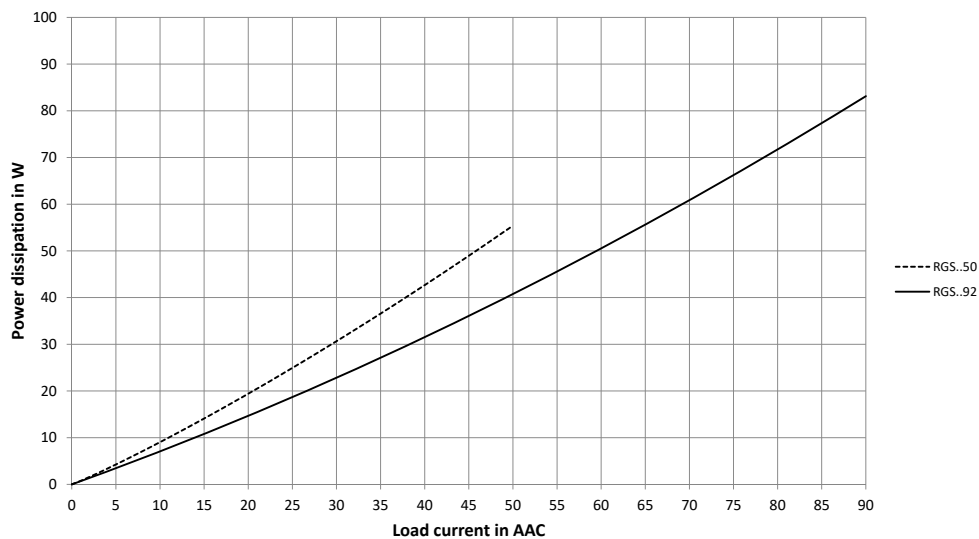

RGC..

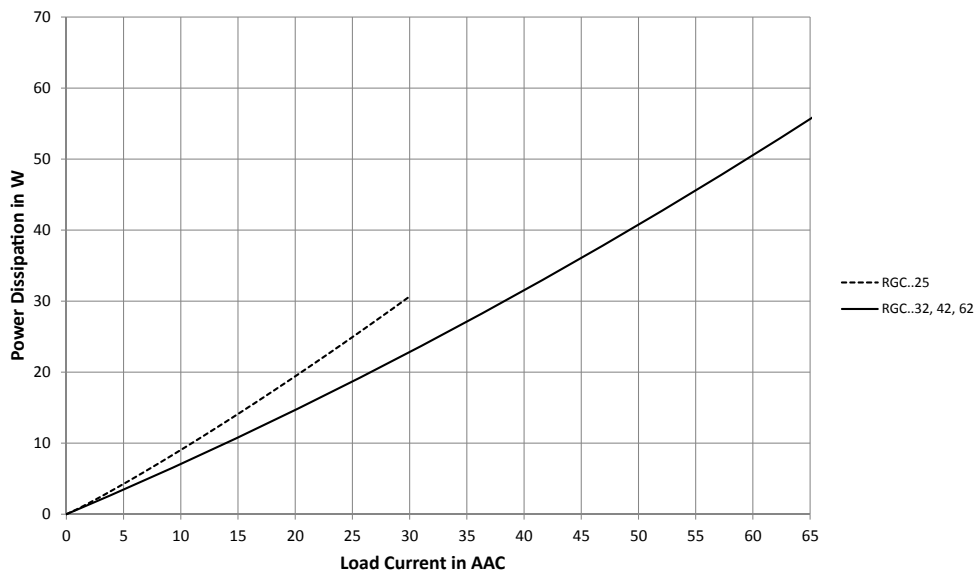

▶ RGS.. Heatsink selection

Note: The heatsink selection in tables below is valid only when a fine layer of silicon based thermal paste (with a similar thermal resistance to that specified for R_{thcs} in the Thermal data section) is utilised. The SSR will overheat if this heatsink selection is used for heatsink assemblies using a thermal interface material having a higher R_{thcs} than indicated in the Thermal data section.

Thermal resistance [°C/W] of RGS..50

	Surrounding ambient temperature [°C]					
Load current per pole AC-51 [A]	20	30	40	50	60	65
50	1.45	1.28	1.06	0.87	0.68	0.59
45	1.72	1.50	1.29	1.07	0.85	0.75
40	2.00	1.75	1.50	1.25	1.00	0.87
35	2.35	2.06	1.76	1.47	1.18	1.03
30	2.83	2.48	2.13	1.77	1.42	1.24
25	3.52	3.08	2.64	2.20	1.76	1.54
20	4.58	4.01	3.44	2.86	2.29	2.01
15	6.40	5.60	4.80	4.00	3.20	2.80
10	10.19	8.92	7.64	6.37	5.10	4.46
5	--	19.51	16.72	13.94	11.15	9.76

Thermal resistance [°C/W] of RGS..92

	Surrounding ambient temperature [°C]					
Load current per pole AC-51 [A]	20	30	40	50	60	65
90	0.62	0.52	0.41	0.31	0.21	0.16
81	0.77	0.66	0.54	0.42	0.31	0.25
72	0.97	0.83	0.70	0.56	0.43	0.36
63	1.23	1.07	0.91	0.75	0.59	0.51
54	1.55	1.35	1.16	0.97	0.77	0.68
45	1.93	1.69	1.45	1.21	0.97	0.85
36	2.53	2.21	1.89	1.58	1.26	1.11
27	3.55	3.11	2.66	2.22	1.77	1.55
18	5.67	4.97	4.26	3.55	2.84	2.48
9	12.46	10.90	9.34	7.79	6.23	5.45

▶ RGS..HT Heatsink selection for variants with pre-attached thermal pad

Note: The heatsink selection in tables below is valid for the models having a pre-attached thermal interface (RGS..HT). The thermal resistance R_{thcs_HT} of the interface used is noted in the Thermal data section (ref. RGHT). In case of replacements, a thermal interface pad having the same or lower thermal resistance shall be utilised to prevent SSR from overheating.

Thermal resistance [°C/W] of RGS..50..HT

Load current per pole AC-51 [A]	Surrounding ambient temperature [°C]					
	20	30	40	50	60	65
50	0.84	0.65	0.46	0.27	0.08	--
45	1.12	0.90	0.69	0.47	0.25	0.15
40	1.47	1.22	0.97	0.72	0.47	0.35
35	1.94	1.64	1.35	1.06	0.76	0.62
30	2.57	2.22	1.86	1.51	1.15	0.98
25	3.48	3.03	2.59	2.15	1.71	1.49
20	4.58	4.01	3.44	2.86	2.29	2.01
15	6.40	5.60	4.80	4.00	3.20	2.80
10	10.19	8.92	7.64	6.37	5.10	4.46
5	--	19.51	16.72	13.94	11.15	9.76

Thermal resistance [°C/W] of RGS..92..HT

Load current per pole AC-51 [A]	Surrounding ambient temperature [°C]					
	20	30	40	50	60	65
90	0.07	--	--	--	--	--
81	0.22	0.11	--	--	--	--
72	0.42	0.28	0.15	0.01	--	--
63	0.68	0.52	0.35	0.20	0.04	--
54	1.03	0.84	0.65	0.45	0.26	0.16
45	1.54	1.30	1.05	0.81	0.57	0.45
36	2.32	2.00	1.69	1.37	1.05	0.90
27	3.55	3.11	2.66	2.22	1.77	1.55
18	5.67	4.97	4.26	3.55	2.84	2.48
9	12.46	10.90	9.34	7.79	6.23	5.45

▶ RGS.. Thermal data

	RGS..50	RGS..92
Max. junction temperature	125°C	
Heatsink temperature	100°C	
Junction to case thermal resistance, R_{thjc}	< 0.30°C/W	< 0.20°C/W
Case to heatsink thermal resistance, R_{thcs}^3	< 0.25°C/W	
Case to heatsink thermal resistance (RGS..HT), $R_{thcs_HT}^4$	< 0.85 °C/W	< 0.80 °C/W

3. Thermal resistance case to heatsink values are applicable upon application of a fine layer of silicon based thermal paste HTS02S from Electrolube between SSR and heatsink.

4. Thermal resistance case to heatsink values for RGS..HT are applicable for the RGHT thermal pad that is pre-attached from the factory to the RGS.

RG.. Current derating

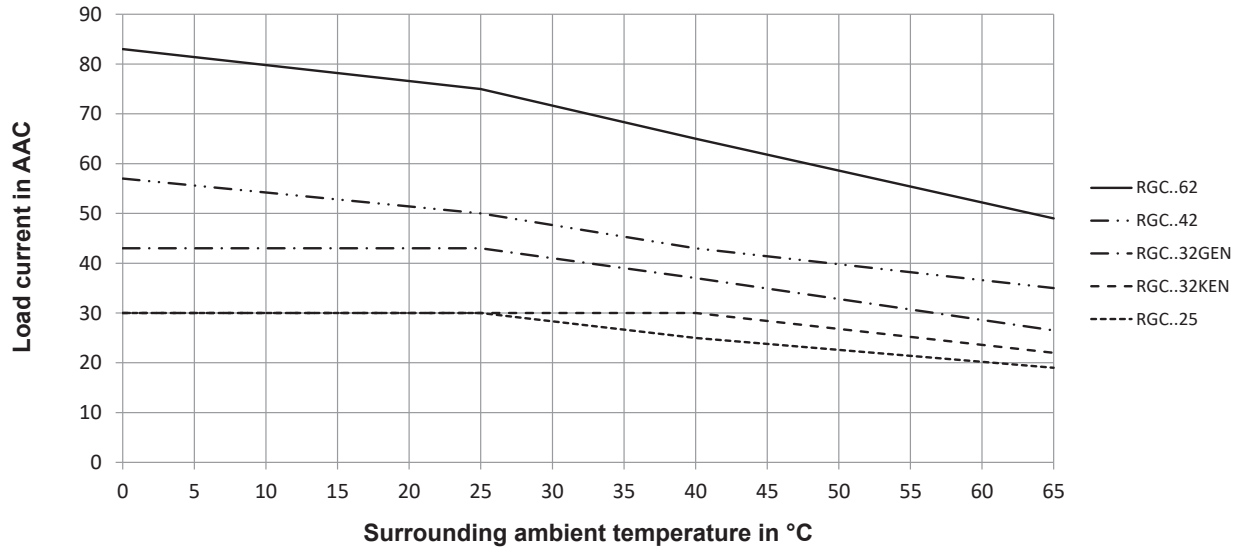

RG.. Derating vs spacing

RG...25

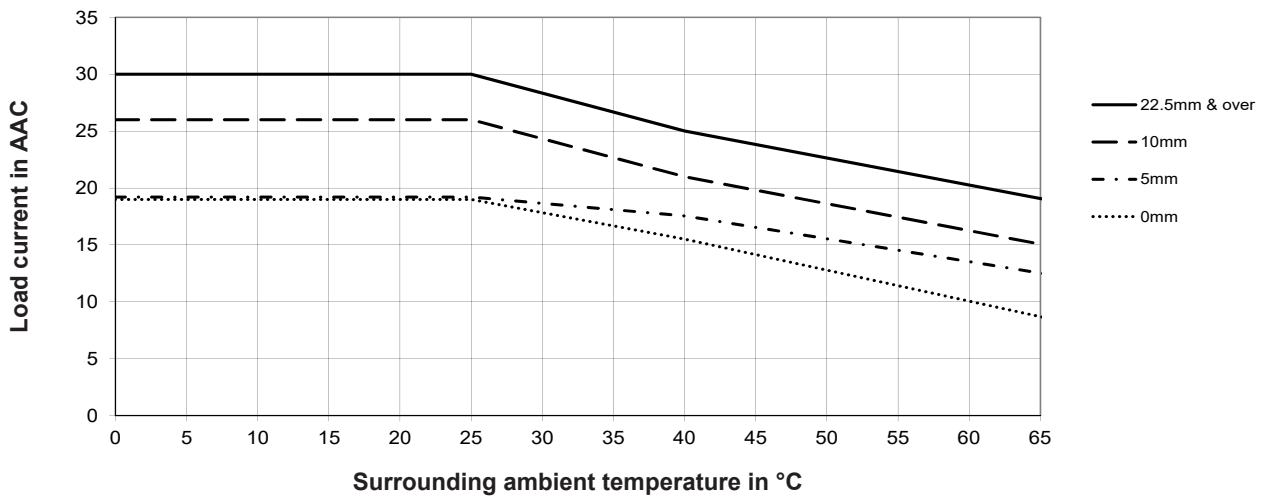



RGC...32

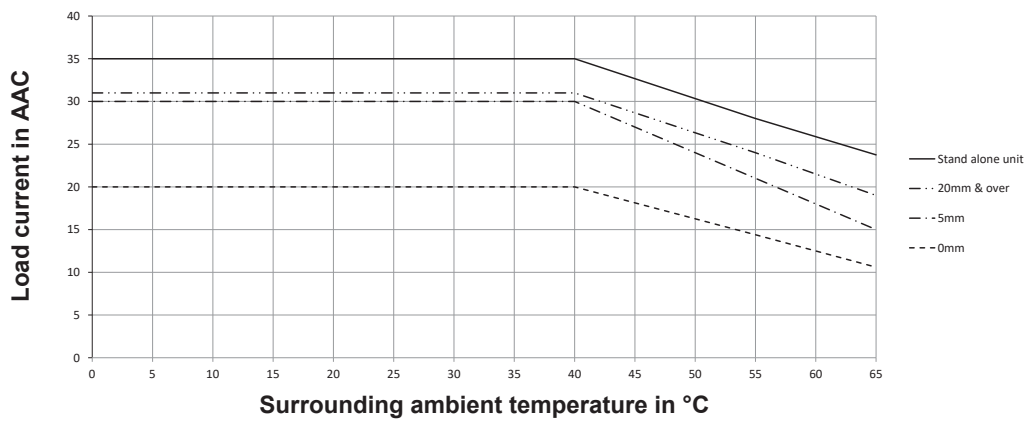



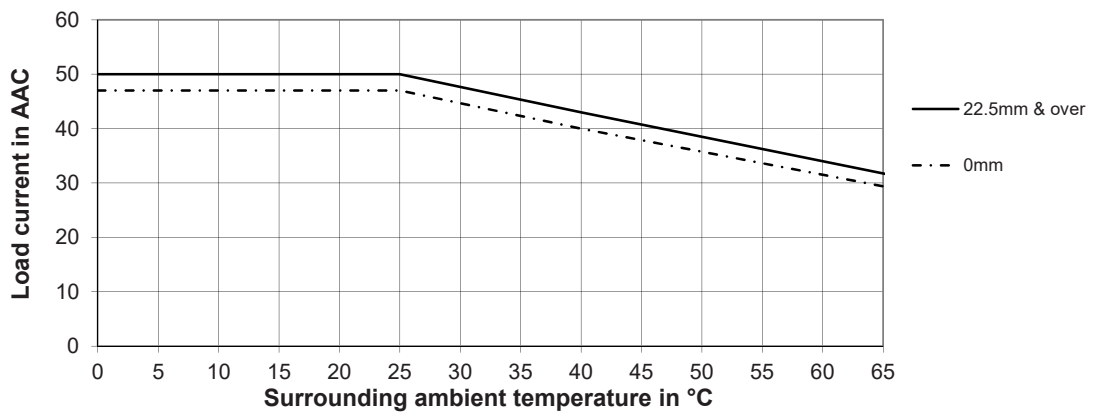



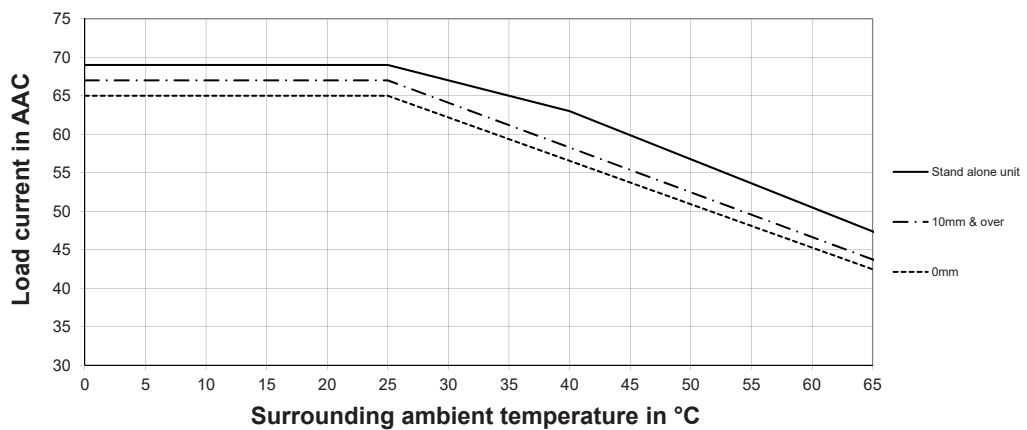





RGC...42



RGC...62



Compatibility and conformance

Approvals	RGC:     
	RGS:       
Standards compliance	LVD: EN 60947-4-3 / EE BS EN 60947-4-3 EMCD: EN 60947-4-3 / EMC BS EN 60947-4-3 UL: UL508, E172877, NMFT cUL: C22.2 No. 14-18, E172877, NMFT7 UR: UL508, E172877, NMFT2 cUR: C22.2 No. 14-18, E172877, NMFT8 CCC: GB/T 14048.5-2017 (IEC 60947-5-1)
UL short circuit current rating	100k Arms (refer to short circuit protection section, Type 1 – UL508)

Electromagnetic compatibility (EMC) - Immunity	
Electrostatic discharge (ESD)	EN/IEC 61000-4-2 8 kV air discharge, 4 kV contact (PC1)
Radiated radio frequency ⁵	EN/IEC 61000-4-3 10 V/m, from 80 MHz to 1 GHz (PC1) 10 V/m, from 1.4 to 2 GHz (PC1) 3 V/m, from 2 to 2.7 GHz (PC1)
Electrical fast transient (burst)	EN/IEC 61000-4-4 Output: 2 kV, 5 kHz & 100 kHz (PC1) Input, BUS: 1 kV, 5 kHz & 100 kHz (PC1)
Conducted radio frequency ⁵	EN/IEC 61000-4-6 10 V/m, from 0.15 to 80 MHz (PC1)
Electrical surge	EN/IEC 61000-4-5 Output, line to line: 1 kV (PC2) Output, line to earth: 2 kV (PC2) BUS (Supply), line to line: 500 V (PC2) BUS (Supply), line to earth: 500 V (PC2) BUS (Data), A1-A2, line to earth: 1 kV (PC2) ⁶
Voltage dips	EN/IEC 61000-4-11 0% for 0.5, 1 cycle (PC2) 40% for 10 cycles (PC2) 70% for 25 cycles (PC2) 80% for 250 cycles (PC2)
Voltage interruptions	EN/IEC 61000-4-11 0% for 5000ms (PC2)

5. Under the influence of RF, a reading error of ± 10% was allowed for load currents > 500 mA and ± 20% for load currents < 500 mA. These tolerances are not maintained if Ref signal is not connected.

6. Not applicable to shielded cables < 10 m. Additional suppression on data lines may be required if shielded cables are not used.

Electromagnetic compatibility (EMC) - Emissions	
Radio interference field emission (radiated)	EN/IEC 55011 Class A: from 30 to 1000 MHz
Radio interference voltage emissions (conducted)	EN/IEC 55011 Class A: from 0.15 to 30 MHz (External filter may be required - refer to Filtering section)

Filter connection diagram

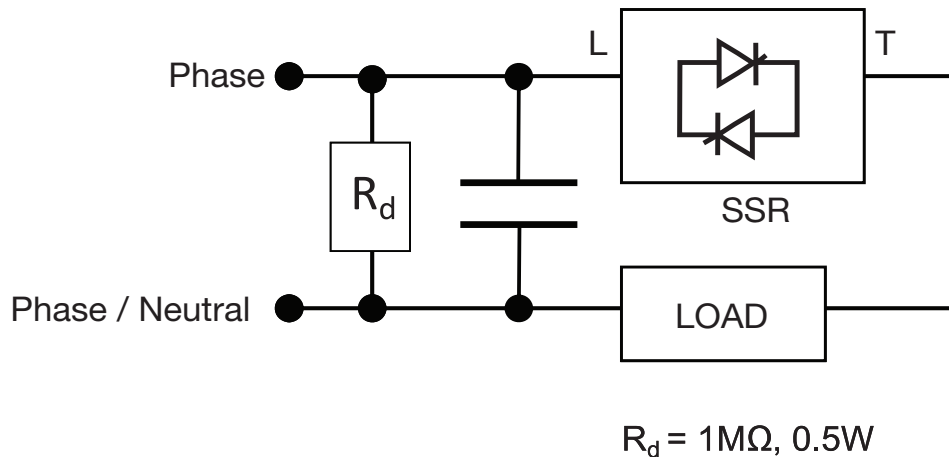

Filtering

Part number	Suggested filter for EN 55011 Class A compliance			Maximum heater current [AAC]
	ON / OFF	Phase angle - RGx1P..N only	Other switching modes	
RGS..50	220 nF / 760 V / X1	SCHAFFNER, FN2410-45-33 EPCOS, SIFI -H-G136	3.3 uF / 760 V / X1	30 A
RGS..92	680 nF / 760 V / X1	SCHAFFNER, FN2410-60-34	SCHAFFNER, FN2410-60-34 EPCOS, A60R000	60 A
RGS..25	220 nF / 760 V / X1	SCHAFFNER, FN2410-45-33 EPCOS, SIFI -H-G136	3.3 uF / 760 V / X1	30 A
RGC..32	330 nF / 760 V / X1	SCHAFFNER, FN2410-45-33 EPCOS, A50R000 EPCOS, A42R122 EPCOS, SIFI-H-G136	3.3 uF / 760 V / X1	35 A
RGC..42	330 nF / 760 V / X1	SCHAFFNER, FN2410-45-33 EPCOS, A50R000 EPCOS A42R122	3.3 uF / 760 V / X1	43 A

Note:

- Control input lines must be installed together to maintain products' susceptibility to Radio Frequency interference.
- Use of AC solid state relays may, according to the application and the load current, cause conducted radio interferences. Use of mains filters may be necessary for cases where the user must meet E.M.C requirements. The capacitor values given inside the filtering specification tables should be taken only as indications, the filter attenuation will depend on the final application.
- Performance Criteria 1 (PC1): No degradation of performance or loss of function is allowed when the product is operated as intended.
- Performance Criteria 2 (PC2): During the test, degradation of performance or partial loss of function is allowed. However when the test is complete the product should return operating as intended by itself.
- Performance Criteria 3 (PC3): Temporary loss of function is allowed, provided the function can be restored by manual operation of the controls.

Environmental specifications

Operating temperature	-20 to +65 °C (-4 to +149 °F)
Storage temperature	-20 to +65 °C (-4 to +149 °F)
Relative humidity	95% non-condensing @ 40°C
Pollution degree	2
Installation altitude	0-1000m Above 1000 m derate linearly by 1% of FLC per 100m up to a maximum of 2000 m
Vibration resistance	2g/ axis (2-100Hz, IEC60068-2-6, EN 50155)
Impact resistance	15/11 g/ms (EN 50155)
EU RoHS compliant	Yes
China RoHS	

The declaration in this section is prepared in compliance with People's Republic of China Electronic Industry Standard SJ/T11364-2014: Marking for the Restricted Use of Hazardous Substances in Electronic and Electrical Products.

Part Name	Toxic or Harardous Substances and Elements					
	Lead (Pb)	Mercury (Hg)	Cadmium (Cd)	Hexavalent Chromium (Cr(VI))	Polybrominated biphenyls (PBB)	Polybrominated diphenyl ethers (PBDE)
Power Unit Assembly	x	0	0	0	0	0

O: Indicates that said hazardous substance contained in homogeneous materials for this part are below the limit requirement of GB/T 26572.

X: Indicates that said hazardous substance contained in one of the homogeneous materials used for this part is above the limit requirement of GB/T 26572.

这份申明根据中华人民共和国电子工业标准 SJ/T11364-2014：标注在电子电气产品中限定使用的有害物质

零件名称	有毒或有害物质与元素					
	铅 (Pb)	汞 (Hg)	镉 (Cd)	六价铬 (Cr(VI))	多溴化联苯 (PBB)	多溴联苯醚 (PBDE)
功率单元	x	0	0	0	0	0

O:此零件所有材料中含有的该有害物低于GB/T 26572的限定。

X: 此零件某种材料中含有的该有害物高于GB/T 26572的限定。

Switching modes

ON-OFF Mode

The ON-OFF mode controls the solid state relays at the user's command. All the RG..Ns on the bus chain can be controlled at the same time.

The advantages of this mode are:

- It is effectively a direct replacement of the A1-A2, i.e. for existing systems, the control algorithm within the PLC can be left relatively untouched and the output is redirected via the communication interface instead of the PLC output modules.
- One command can set the state of the whole bus chain.

Burst Firing Mode

The Burst firing mode works with a control level and a time-base which can be varied by user from 0.1 seconds to 10 seconds. The percentage ON time is then determined by the control level. Therefore, with a control level of 10% ;10% of the time-base will be ON and 90% will be OFF. The figure below shows example waveforms of this firing mode at different control levels. In this example the time base was set to 1 second. The percentage control resolution depends on the timebase set by the user. To achieve a 1% resolution, the time base has to be a minimum of 2 sec for 50 Hz and 1.7 sec for 60 Hz.

Output with Burst firing mode @ 33% control level:

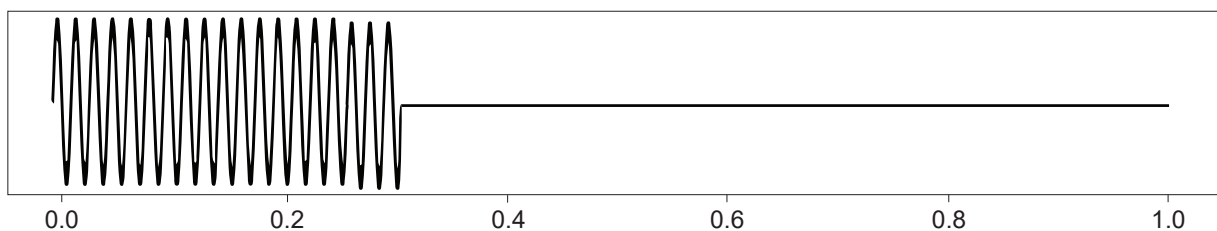

Output with Burst firing mode @ 50% control level:

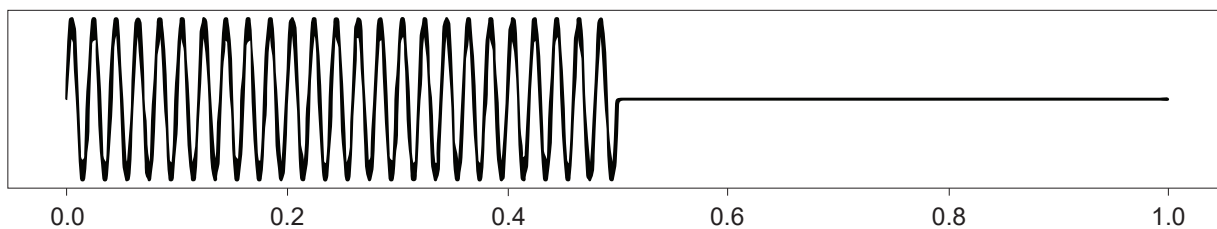

Output with Burst firing mode @ 66% control level:

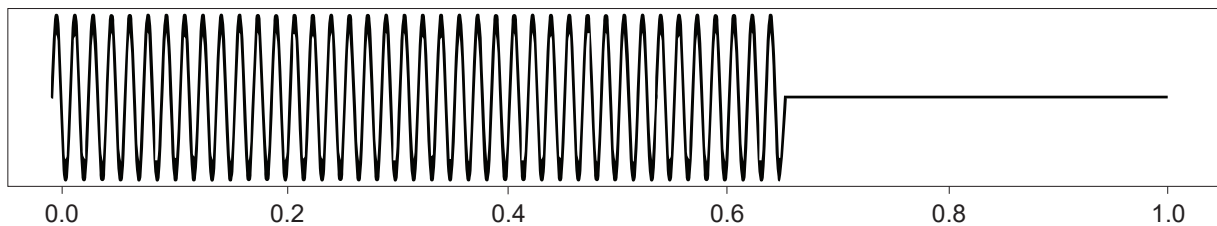

Switching modes (Continued)

Distributed Firing Mode

The Distributed firing mode works with a control level and a fixed time-base of 100 full cycles (2 seconds for 50 Hz). This mode operates with full cycles and it distributes the ON cycles as evenly as possible over the time base. In this mode, since the resolution is 1% and the time base is of 100 full cycles, the control level is equal to the number of full cycles over the whole time base.

1% = 1 full cycle every 100 cycles

2% = 2 full cycles every 100 cycles = 1 full cycle every 50 cycles

Output with Distributed firing mode @ 33% control level:

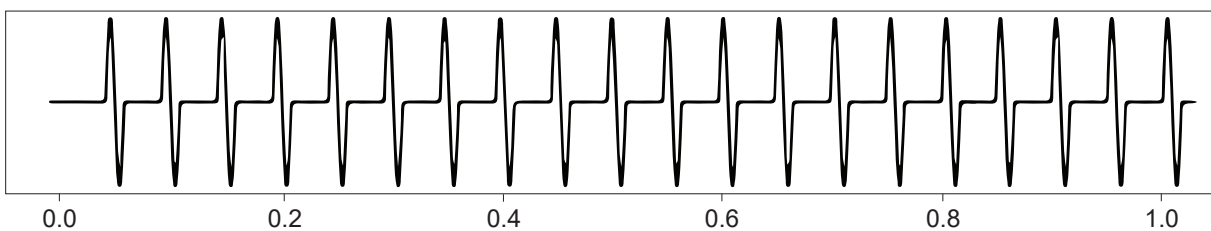

Output with Distributed firing mode @ 50% control level:

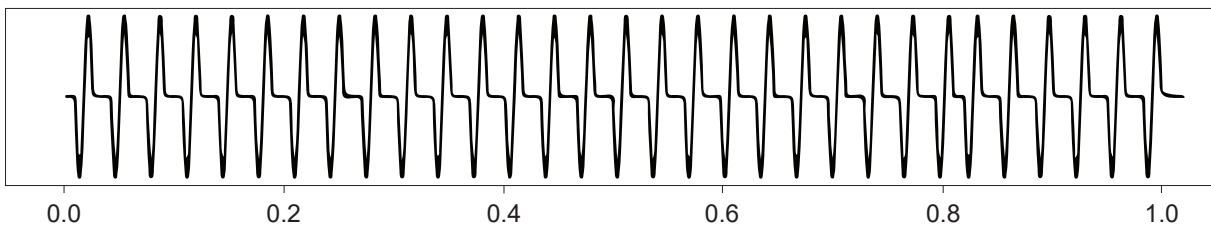

Output with Distributed firing mode @ 66% control level:

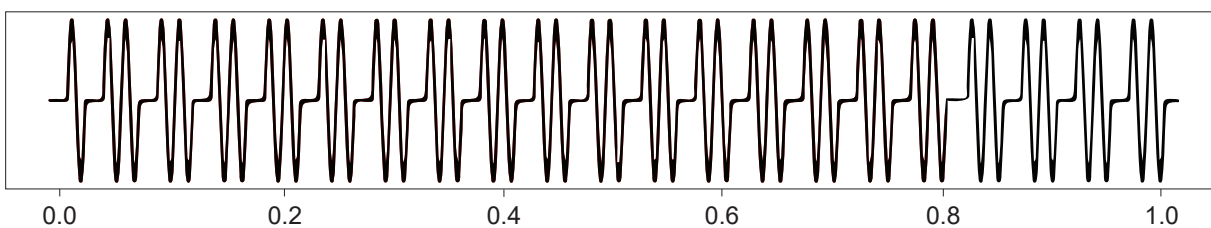

The advantage of Distributed over Burst is the reduction in thermal cycling. On the other hand, Distributed suffers from worse harmonics/emissions than Burst.

Switching modes (Continued)

Advanced Full Cycle Firing

Advanced Full Cycle (AFC) firing works on the same concept as Distributed but rather than distributing full cycles, half cycles are distributed. This mode also works over a time base of 100 full cycles (200 half cycles). In this mode, since the resolution is 1% and the time base is of 100 full cycles, the control level is equal to the number of full cycles over the whole time base.

1% = 2 half cycles every 200 half cycles = 1 half cycle every 100 half cycles
 2% = 4 half cycles every 200 half cycles = 1 half cycle every 50 half cycles

Output with Advanced full cycle firing mode @ 33% control level:

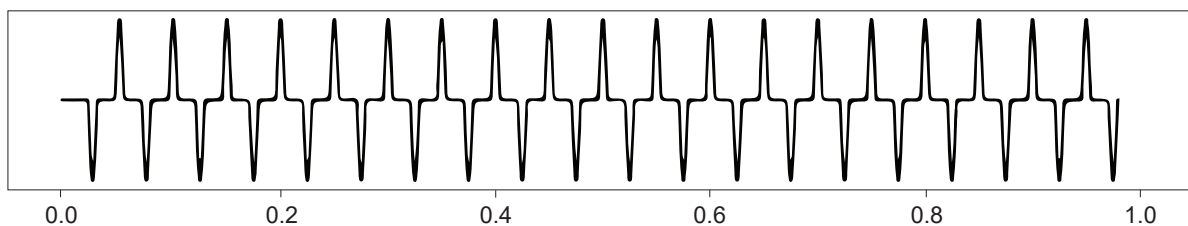

Output with Advanced full cycle firing mode @ 50% control level:

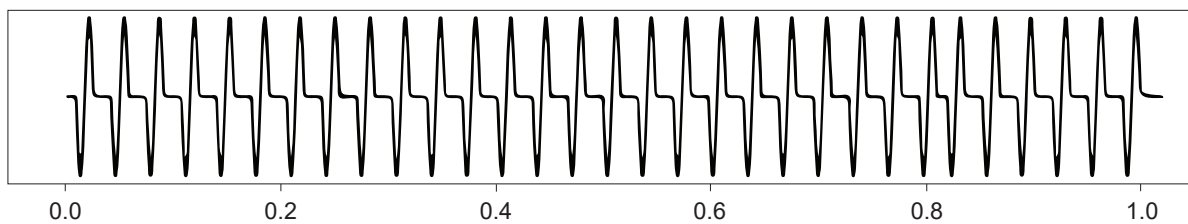

Output with Advanced full cycle firing mode @ 66% control level:

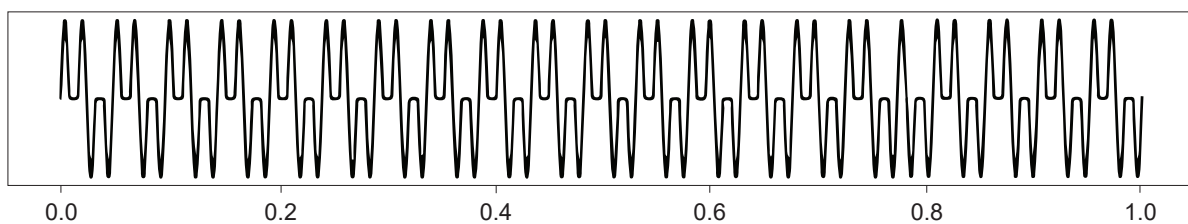

The advantage of AFC over Burst is the reduction in thermal cycling. Another advantage of AFC is that visual flicker is less noticeable than Distributed thus making it suitable for shortwave infrared heater applications.

AFC has the disadvantage of worse harmonics/emissions than Burst and also slightly worse than Distributed.

Switching modes (Continued)

Phase angle Mode (available only on RGx1P..CM..N)

The Phase Angle switching mode works in accordance with the phase angle control principle. The power delivered to the load is controlled by the firing of the thyristors over each half mains cycle. The firing angle depends on the control level that determines the output power to be delivered to the load. The power to the load is varied linearly with the control level.

Output with Phase Angle mode @ 33% control level:

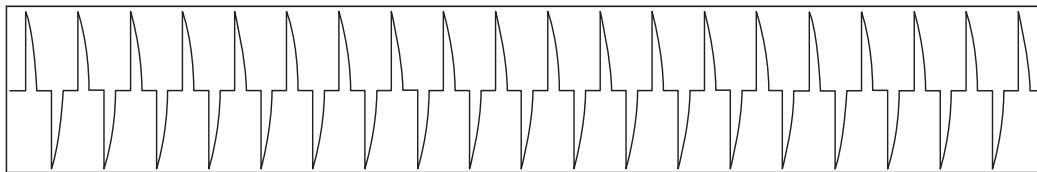

Output with Phase Angle mode @ 50% control level:

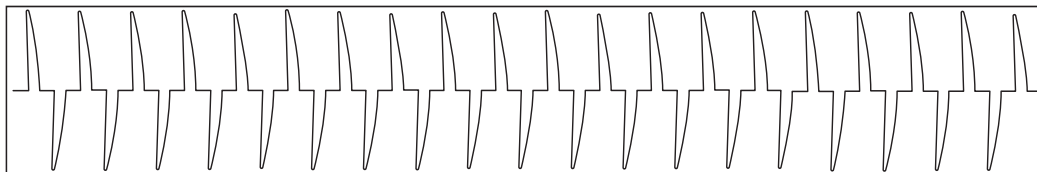

Output with Phase Angle mode @ 66% control level:

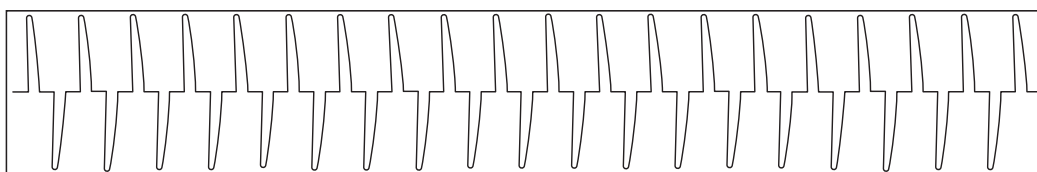

The advantage of Phase Angle over the other switching modes is its precise resolution of power. However, Phase Angle generates excessive harmonics vs other switching modes. With Phase Angle control, the flickering of IR heaters is eliminated completely.

Switching modes (Continued)

Soft starting (available only on RGx1P.CM..N)

Soft starting is utilised to reduce the start-up current of loads having a high cold-to-hot resistance ratio such as short wave infrared heaters. The thyristor firing angle is gradually increased in order to apply the power to the load smoothly. Soft start can be applied with all the other available switching modes (ON/OFF, Burst, Distributed full cycle, Advanced full cycle and Phase angle). When applied with phase angle, the soft start will stop at the set control level whereas for the other switching mode the soft start will stop until fully ON. Soft start shall be applied upon power up and after a number of non-firing cycles settable by the user (check the User manuals for each communication protocol for more information).

Soft start with phase angle

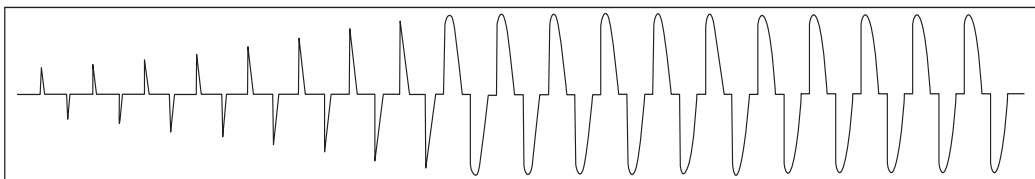

Soft start with ON/OFF, Burst, Distributed full cycle and Advanced full cycle

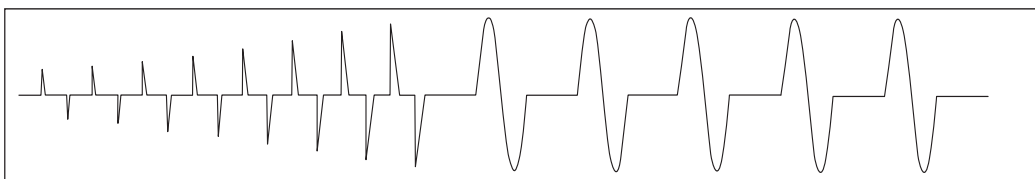

There are two type of soft start modes on the RGx1P.CM..N:

Soft start with time mode

This soft start mode will apply the power smoothly to the load over a time period of maximum 25.5s (settable by the user via the communication). Check the user manual of each available communication protocol for more information.

Soft start with current limit mode

This soft start mode works with a current limit set by the user via the communication. The soft start time will adapt such that the set current limit is not exceeded and the soft start occurs in the shortest amount for time. The recommended setting for the current limit is 1.2 - 1.5 times the nominal current. The maximum settable current limit is 2 times the rated current of the RG..CM..N variant used. If the current limit is set too low and is reached before soft start is completed, a warning will be notified via the communication. Check the user manual of each available communication protocol for more information.

Voltage compensation

When voltage compensation is utilised, the power on the output of the solid state relay will remain balanced despite any voltage deviations from normal readings. The algorithm uses a reference voltage set by the user via the communication to compute the compensation factor. A new control level is calculated by applying the compensation factor on the control level from the main controller. Check the user manual of each available communication protocol for more information.

The compensation factor (C.F.) applied on the control level is calculated as follows:

$$C.F. = \left(\frac{Reference\ Voltage}{Measured\ Voltage} \right)^2$$



Measurements

Parameter	Description
Current	This reports the measured load RMS current.
Hold current	The average current of the last 16 ON half cycles. This measurement can be used for I ² control
Voltage	RMS voltage reading (L1-Ref voltage) that is the supply voltage across the SSR + load (Ref signal connection is required)
Frequency	This reports the measured line frequency.
Apparent power	This reports the apparent power that is a multiplication of the voltage RMS value and current RMS value. (Ref signal connection is required)
Real power	This reports the real power reading that is based on the instantaneous voltage & current multiplications. (Ref signal connection is required)
SSR Running hours	This is a count of the time during which the SSR output is ON. On switch ON, this parameter reports the recorded value at the last switch OFF.
Load Running hours	This is a count of the time during which the output of SSR is ON. On switch ON, this parameter reports the last value before switch OFF. This measurement can be modified in case of a load or SSR replacement.
Energy Consumption	This reports the energy reading in kWh. On switch ON, this parameter reports the recorded value at the last switch OFF. (Ref signal connection is required)

Note 1: For further information refer to the respective NRG user manual for each communication protocol.

Note 2: Ref signal connection is recommended with loads less than 1A

LED indicators

LOAD	Green 	The Load LED reflects the status of the load depending on the presence of the control signal. During an over-temperature condition, the LOAD LED will behave according to the indications in the table "LOAD LED indications in over-temperature condition" below	
BUS	Yellow 	ON:	During a response from the RG..N to the NRGC..
		OFF:	Communication between the NRGC.. and RG..Ns is idle or during the transmission of a command from the NRGC.. to the RG..N
ALARM	Red 	ON:	Fully ON or flashing when alarm condition is present. Refer to Alarm Management section
		OFF:	No alarm condition

LOAD LED indications in over-temperature condition

Control signal	RG..N supply (through internal bus by RCRGN..)	Over-temperature condition	LOAD LED green 
ON	OFF	Detection not possible without BUS connected	ON ⁷ OFF ⁸
ON	ON	OFF	ON
ON	ON	ON	OFF
OFF	OFF	Detection not possible without BUS connected	OFF
OFF	ON	ON	OFF
OFF	ON	OFF	OFF

7. If control signal is via A1-A2 (Not applicable for RGx1P..CM..N)

8. If control signal is via BUS

Alarm management

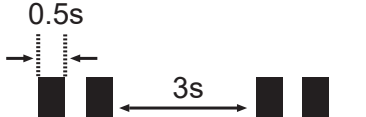
Alarm condition present	<ul style="list-style-type: none"> The state of the Red LED of the respective RG..N is ON with a specific flashing rate All alarms are accessible via the communication interface. <p>For further information refer to the respective NRG user manual for each communication protocol.</p>	
Alarm types	No. of flashes	Description of fault
	100% ON	<p>Over-temperature:</p> <ul style="list-style-type: none"> The RG..N is operating outside its operating range causing the junction to overheat The output of the RG..N is switched OFF (irrespective of the control presence) to prevent damage to the RG..N The alarm is restored automatically after the cooling-off period
	1	<p>Load deviation:</p> <p>Load deviation is activated if the values of the Voltage Reference and Current Reference are > 0 either through a 'TEACH' command or updated manually. This alarm is issued if a change in current > than the Percentage Deviation is detected. This alarm is issued only if a change in current is irrespective of a change in voltage. For further information refer to the respective NRG user manual for each communication protocol.</p>
	2	<p>Mains loss:</p> <p>Voltage and current signals are absent. The cause is a mains loss (with REF terminal connected). Without 'REF' terminal this alarm will indicate a mains loss or a load loss.</p>
	3	<p>Load loss / SSR open circuit:</p> <p>Load is not switching ON when control signal is present. The cause is either a load loss or a RG..N open circuit condition</p>
	4	<p>SSR short circuit:</p> <p>Current flowing through the RG..N output in the absence of a control signal</p>
	5	<p>Frequency Out of Range:</p> <ul style="list-style-type: none"> The RG..N is operated outside the range set by the Over Frequency and Under Frequency Limit settings. Default range is 44 – 66 Hz The RG..N will not stop operating if the frequency measured is out of the set range. The alarm is restored automatically when the frequency is back within the expected range
	6	<p>Current Out of Range:</p> <ul style="list-style-type: none"> The RG..N is operated outside the range set by the Over Current and Under Current Limit settings. Default range is 0 – max. rating of the respective RG..N The RG..N will not stop operating if the current measured is out of the set range. The alarm is restored automatically when the current is back within the expected range
	7	<p>Voltage Out of Range:</p> <ul style="list-style-type: none"> The RG..N is operated outside the range set by the Over Voltage and Under Voltage Limit settings. Default range is 0 – 660 V The RG..N will not stop operating if the voltage measured is out of the set range. The alarm is restored automatically when the voltage is back within the expected range
	8	<p>Communication error (BUS):</p> <p>An error in the communication link (internal bus) between the NRGC.. and RG..Ns</p>
	9	<p>Internal error:</p> <p>Bus supply out of range, hardware damage or detection of abnormal conditions</p>
Flashing rate	 <p>The diagram shows a series of rectangular pulses. The width of each pulse is labeled as 0.5s. The time interval between the start of one pulse and the start of the next pulse is labeled as 3s.</p>	

Short circuit protection

Protection Co-ordination, Type 1 vs Type 2:

Type 1 protection implies that after a short circuit, the device under test will no longer be in a functioning state. In Type 2 co-ordination the device under test will still be functional after the short circuit. In both cases, however the short circuit has to be interrupted. The fuse between enclosure and supply shall not open. The door or cover of the enclosure shall not be blown open. There shall be no damage to conductors or terminals and the conductors shall not separate from terminals. there shall be no breakage or cracking of insulating bases to the extent that the integrity of the mounting of live parts is impaired. Discharge of parts or any risk of fire shall not occur.

The product variants listed in the table hereunder are suitable for use on a circuit capable of delivering not more than 100,000 Arms Symmetrical Amperes, 600 Volts maximum when protected by fuses. Tests at 100,000 A were performed with Class J fuses, fast acting; please refer to the table below for maximum allowed ampere rating of the fuse. Use fuses only.

Tests with Class J fuses are representative of Class CC fuses.

Protection co-ordination Type 1 according to UL 508				
Part No.	Prospective short circuit current [kArms]	Max fuse size [A]	Class	Voltage [VAC]
RGS..50, RGC..25	100	30	J or CC	max. 600
RGS..92, RGC..32, RGC..42, RGC..62	100	80	J	max. 600

Protection co-ordination Type 2 with semiconductor fuses						
Part No.	Prospective short circuit current [kArms]	Mersen (Ferraz Shawmut)		Siba		Voltage [VAC]
		Max fuse size [A]	Part number	Max fuse size [A]	Part number	
RGC..25	10	40	6.9xx CP GRC 22x58 /40	32	50 142 06.32	max. 600
	100	40	6.9xx CP GRC 22x58 /40	32	50 142 06.32	max. 600
RGC..32 RGC..42	10	63	6.9xx CP URC 14x51 /63	80	50 194 20.80	max. 600
	10	70	A70QS70-4	80	50 194 20.80	max. 600
	100	63	6.9xx CP URC 14x51 /63	80	50 194 20.80	max. 600
	100	70	A70QS70-4	80	50 194 20.80	max. 600
RGC..62	10	100	6.9xx CP GRC 22x58 /100	100	50 194 20.100	max. 600
	10	100	A70QS100-4	100	50 194 20.100	max. 600
	100	100	6.621 CP URGD 27x60 /100	100	50 194 20.100	max. 600
	100	100	A70QS100-4	100	50 194 20.100	max. 600
RGS..50	10	80	6.621 CP URQ 27x60 /80	50	50 142 06.50	max. 660
	10	70	A70QS70-4	50	50 142 06.50	max. 660
	100	80	6.621 CP URQ 27x60 /80	50	50 142 06.50	max. 660
	100	70	A70QS70-4	50	50 142 06.50	max. 660
RGS..92	10	125	6.621 CP URD 22x58 /125	125	50 194 20.125	max. 660
	10	125	A70QS125-4	125	50 194 20.125	max. 660
	100	125	6.621 CP URD 22x58 /125	125	50 194 20.125	max. 660
	100	125	A70QS125-4	125	50 194 20.125	max. 660

Protection co-ordination Type 2 with Minature Circuit Breakers (M.C.B.s)				
Solid State Relay type	ABB Model no. for Z - type M. C. B. (rated current)	ABB Model no. for B - type M. C. B. (rated current)	Wire cross sectional area [mm ²]	Minimum length of Cu wire conductor [m] ⁹
RGS..50, RGC..25 (1800 A ² s)	1-pole S201 - Z10 (10 A)	S201-B4 (4 A)	1.0	7.6
			1.5	11.4
			2.5	19.0
	S201 - Z16 (16 A)	S201-B6 (6 A)	1.0	5.2
			1.5	7.8
			2.5	13.0
			4.0	20.8
	S201 - Z20 (20 A)	S201-B10 (10 A)	1.5	12.6
			2.5	21.0
	S201 - Z25 (25 A)	S201-B13 (13 A)	2.5	25.0
4.0			40.0	
2-pole S202 - Z25 (25 A)	S202-B13 (13 A)	2.5	19.0	
		4.0	30.4	
RGS..92, RGC..32, RGC..42, RGC..62 (18000 A ² s)	1-pole S201 - Z32 (32 A)	S201-B16 (16 A)	2.5	3.0
			4.0	4.8
			6.0	7.2
	S201 - Z50 (50 A)	S201-B25 (25 A)	4.0	4.8
			6.0	7.2
			10.0	12.0
			16.0	19.2
	S201 - Z63 (63 A)	S201-B32 (32 A)	6.0	7.2
			10.0	12.0
			16.0	19.2

9. Between MCB and Load (including return path which goes back to the mains)

Note: A prospective current of 6 kA and a 230 / 400 V power supply is assumed for the above suggested specifications. For cables with different cross section than those mentioned above please consult Carlo Gavazzi's Technical Support Group.

Dimensions

RGS...KEN

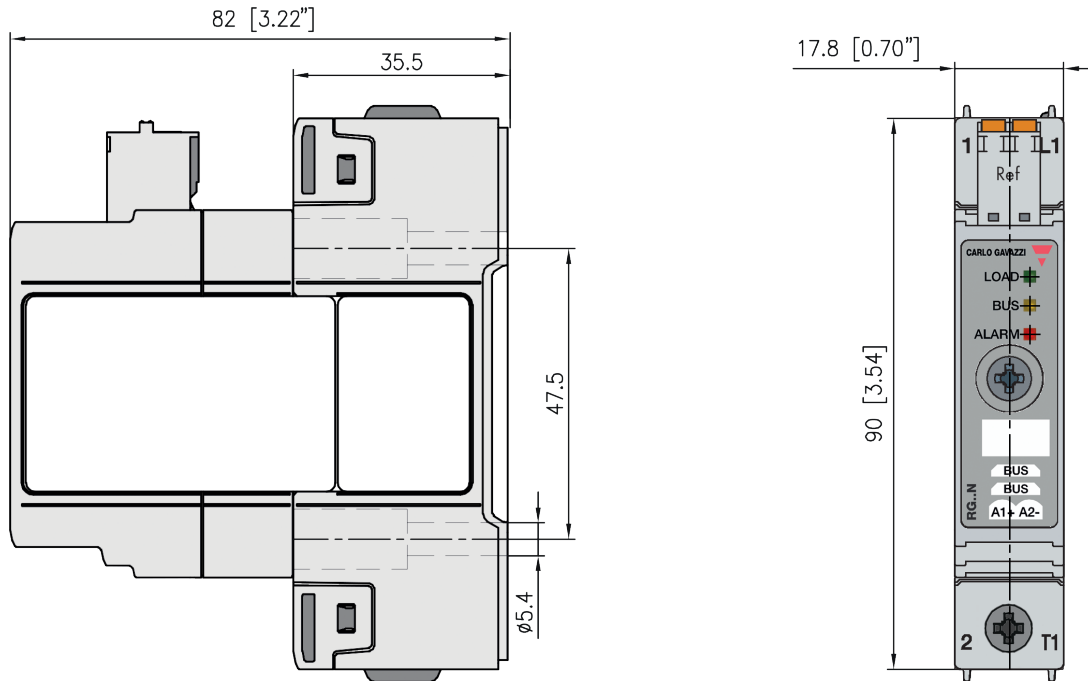

RGS...GEN

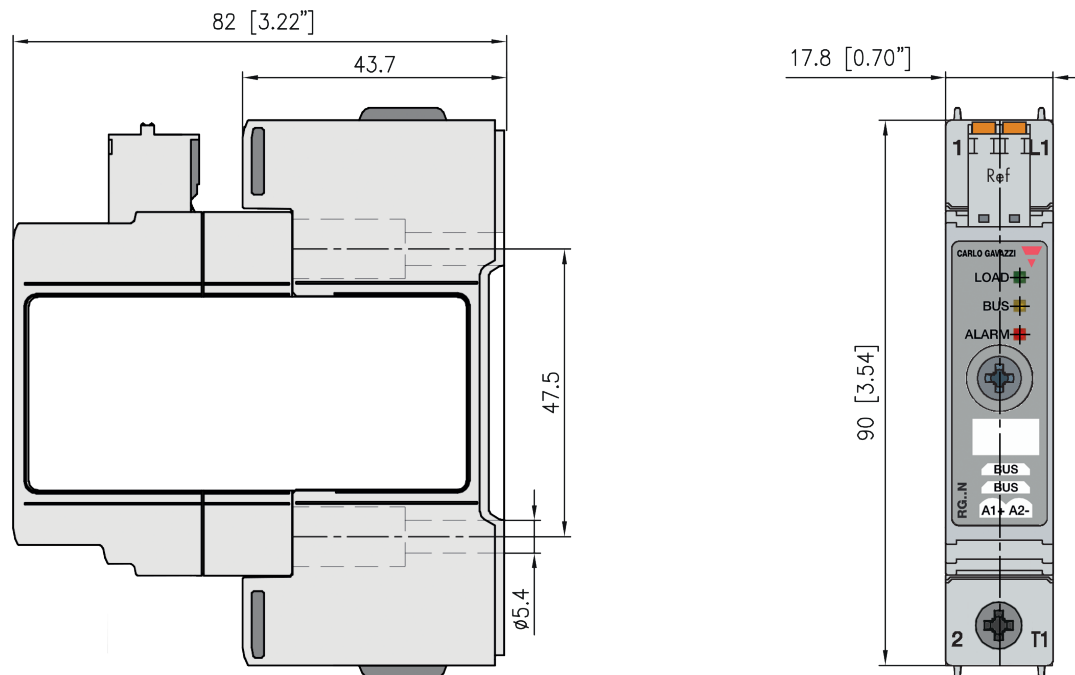

Housing width tolerance +0.5mm, -0mm as per DIN 43880.

All other tolerances +/- 0.5mm.

Dimensions in mm.

Note: Images are for illustrative purposes only

RGC...25KEN, RGC...32KEN

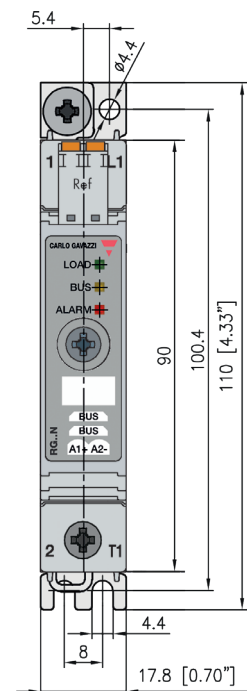
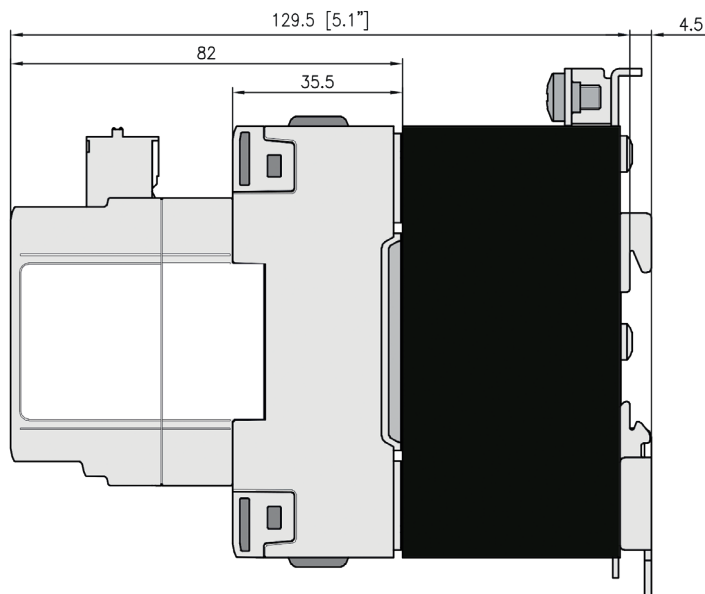

RGC...32GEN

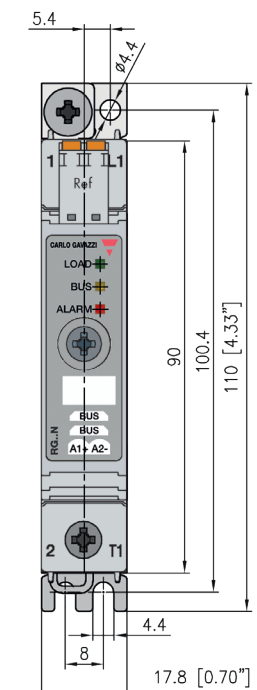
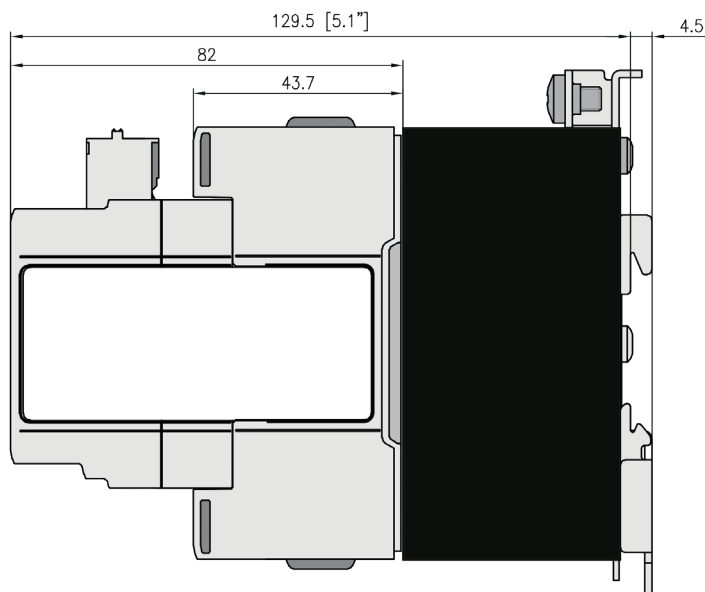

Housing width tolerance +0.5mm, -0mm as per DIN 43880.

All other tolerances +/- 0.5mm.

Dimensions in mm.

Note: Images are for illustrative purposes only

RGC...42GEN

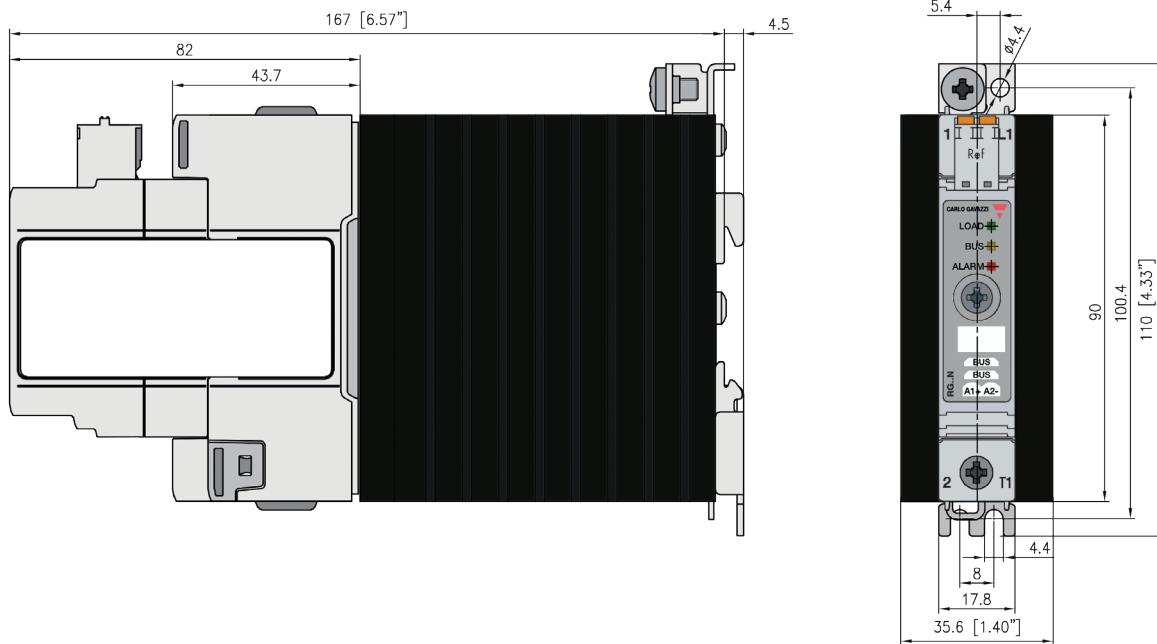

RGC...62GEN

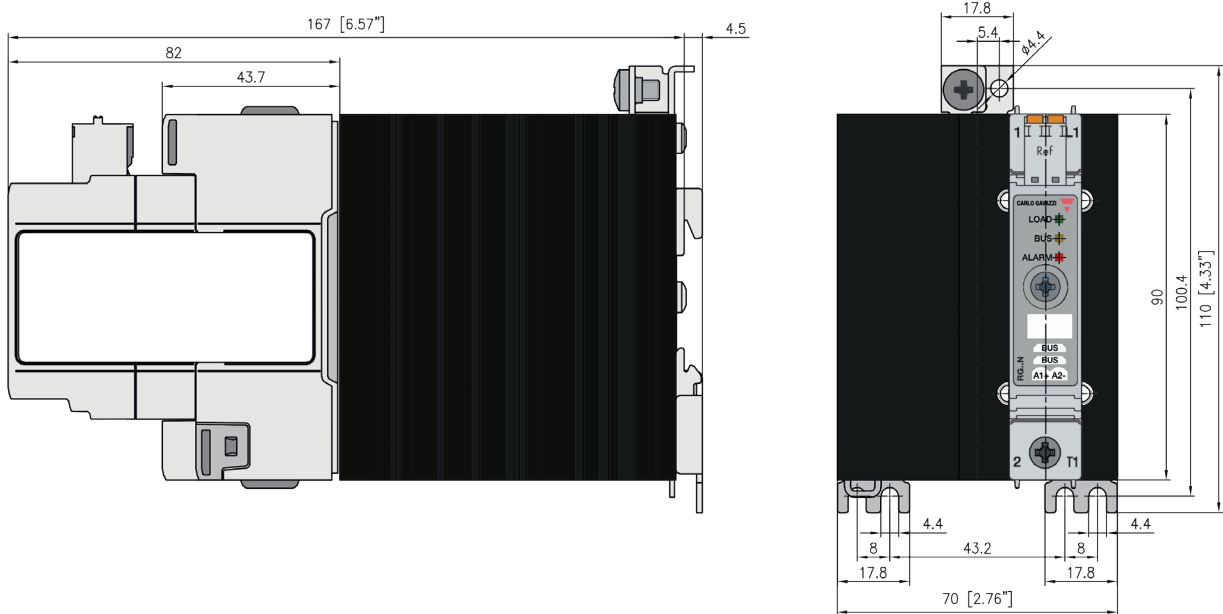

Housing width tolerance +0.5mm, -0mm as per DIN 43880.

All other tolerances +/- 0.5mm.

Dimensions in mm.

Note: Images are for illustrative purposes only

Load connection diagram

Loads connected between phase and neutral. The Ref connections can be looped from one RG..CM..N to another since all the loads have the same return path

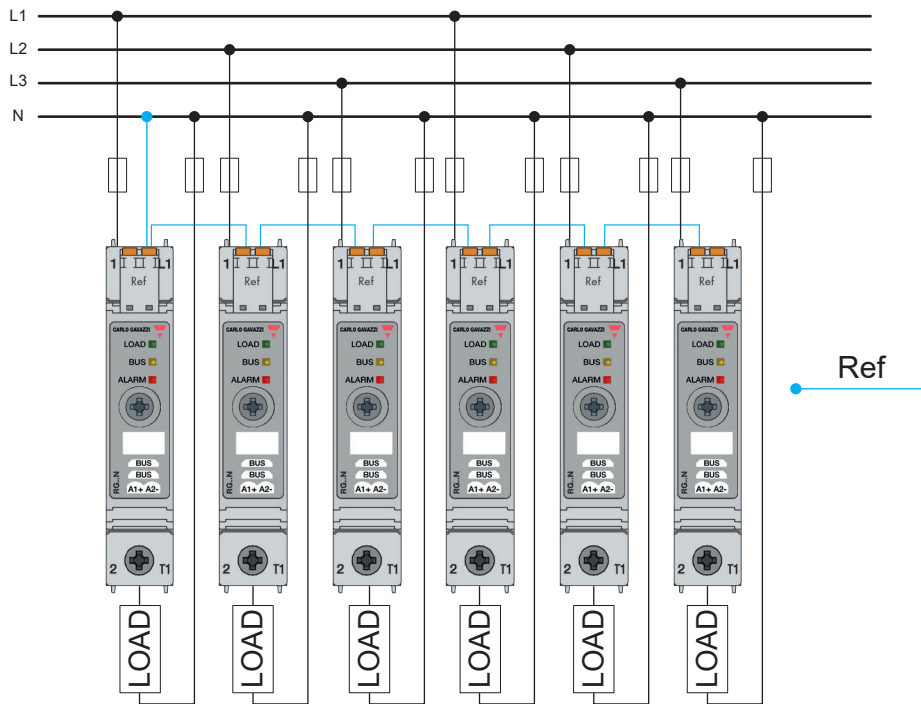

Loads connected between phases. Reference connection (Ref) should always follow the return path of the load

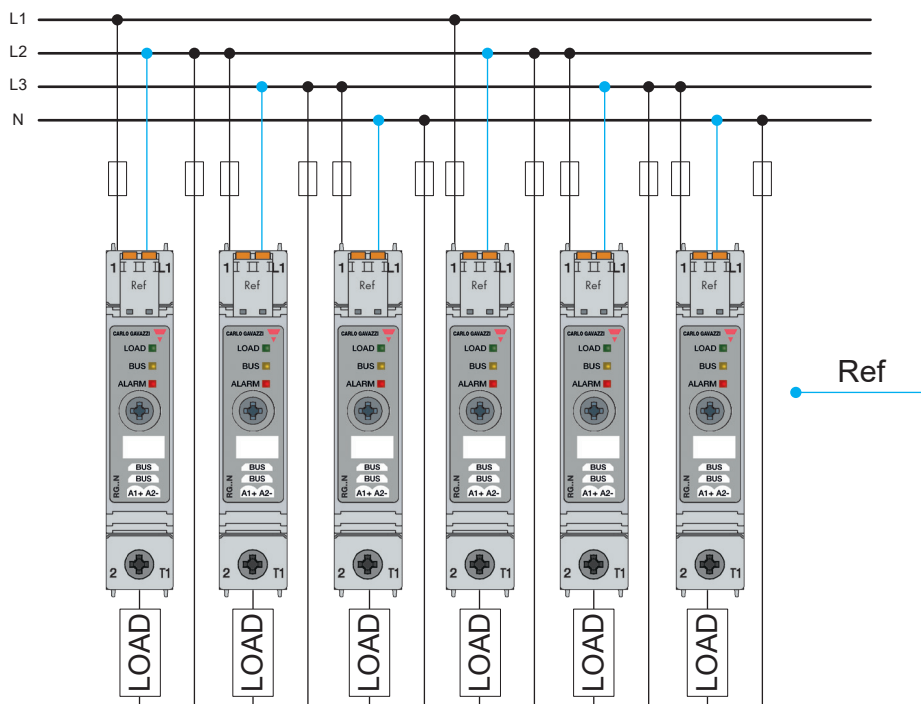

▶ Load connection diagram

The NRG solid state relay can be utilised with 3-phase loads having a star with neutral configuration. The reference connections (Ref) can be looped from one RG..CM..N to another and connected to neutral.

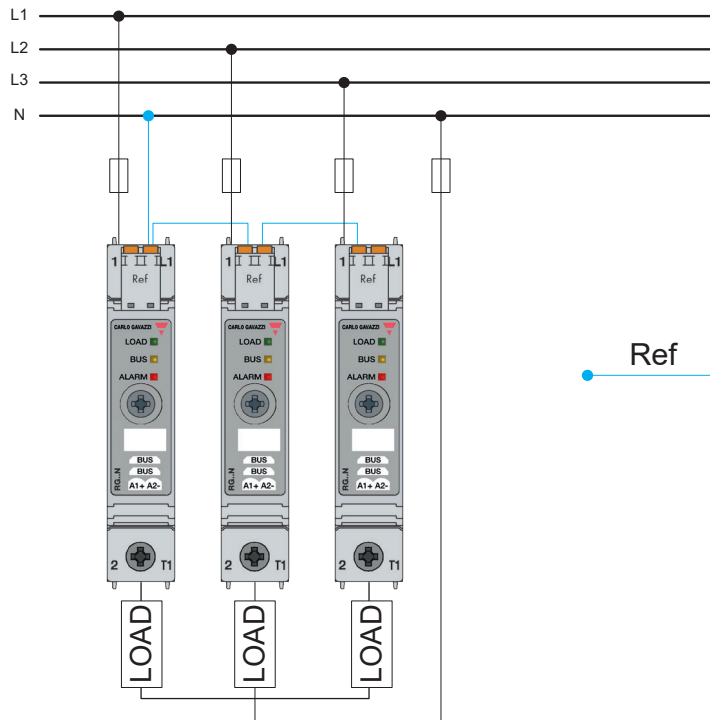

BUS connection diagram

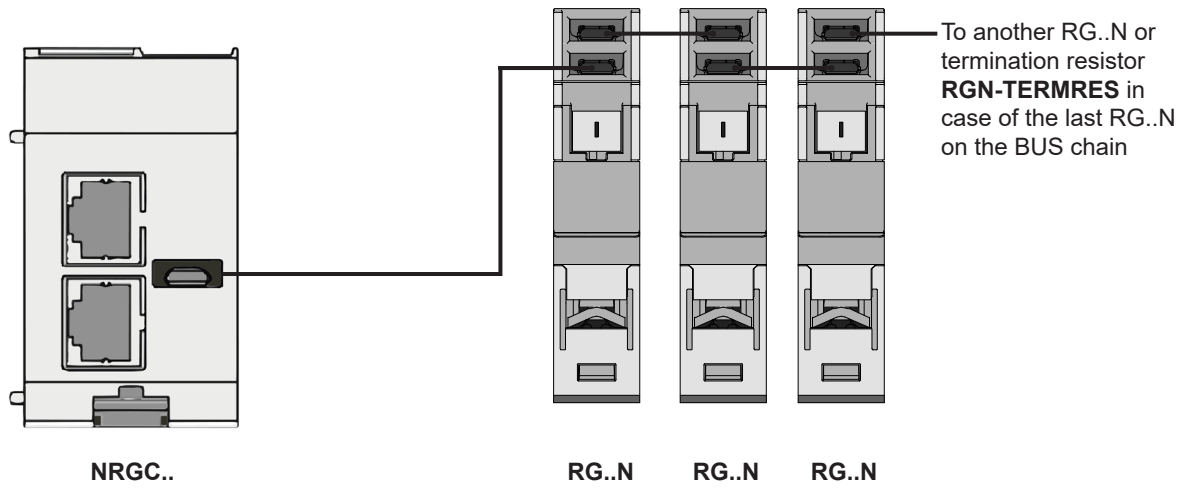

Functional diagram

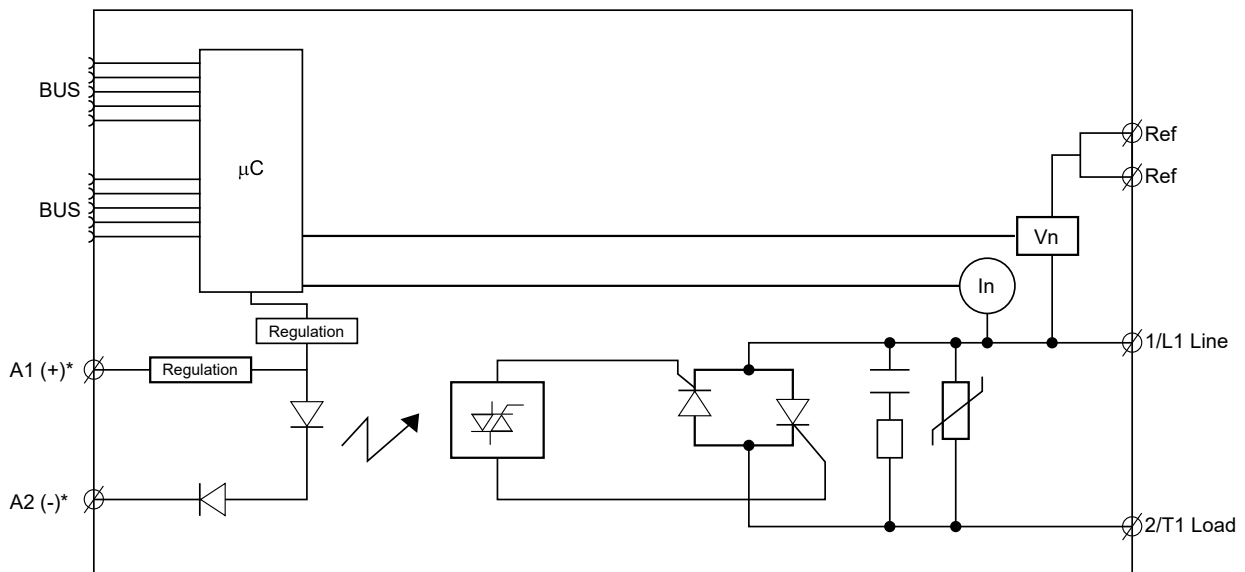

*applies only for external control (Not applicable for RGx1P..CM..N)

▶ Mounting

RGC

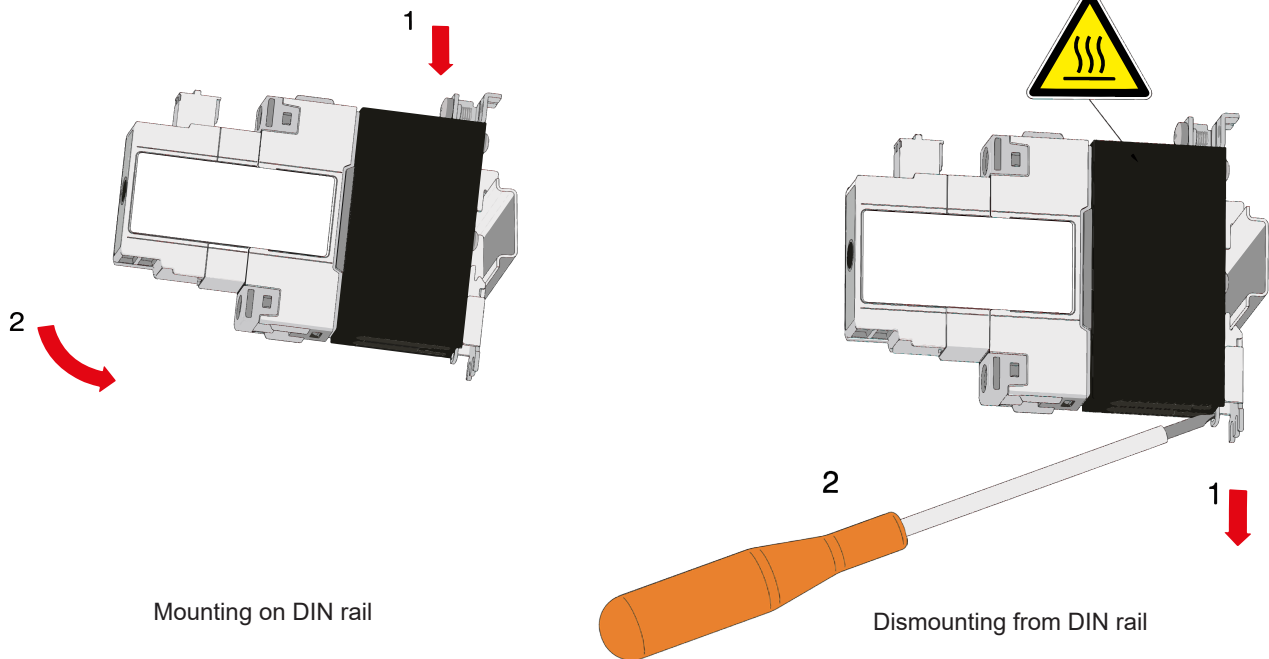

Mounting on DIN rail

Dismounting from DIN rail

RGS

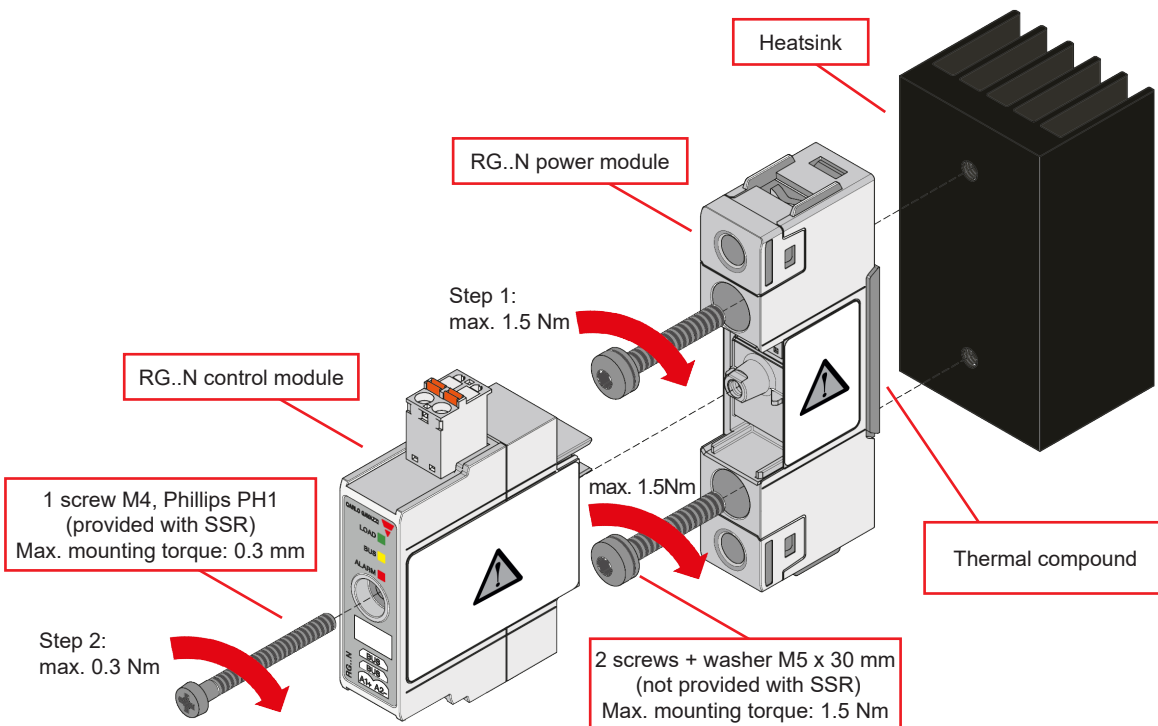

- Step 1: Mount RG..N power module to Heatsink
- Step 2: Mount RG..N control module on RG..N power module



Make sure that the sin code marked on the control unit matches the sin code of the power unit before mounting

Installation

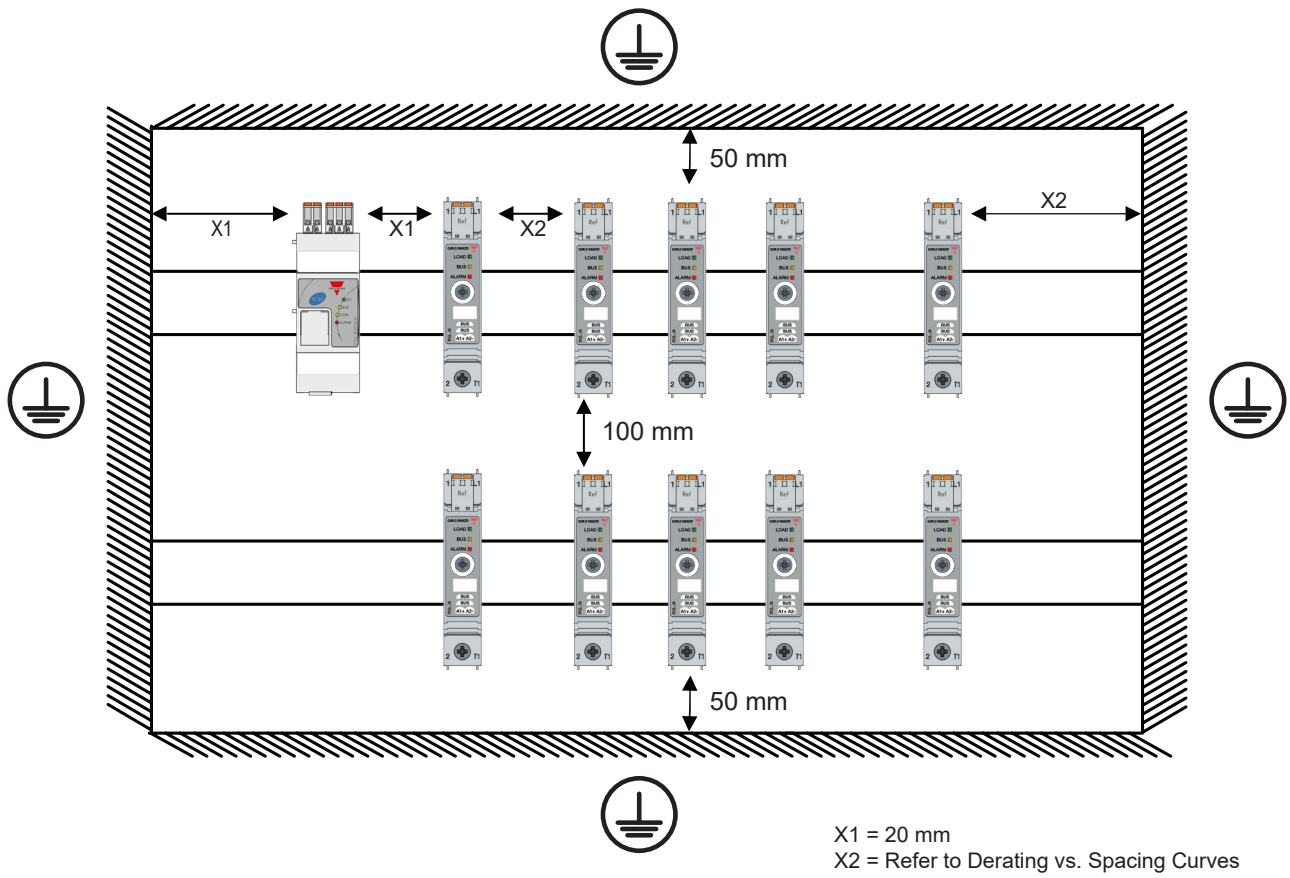

X1 = 20 mm
 X2 = Refer to Derating vs. Spacing Curves



NRG internal bus cables should be isolated from high voltage cables

Connection specifications

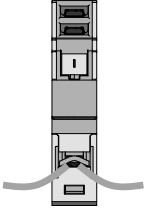
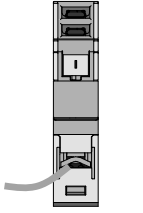
Power connection			
Terminal	1/L1, 2/T1		
Conductors	Use 75°C copper (Cu) conductors		
	RG..KEN	RG..GEN	
			
Stripping length	12mm	11mm	
Connection type	M4 screw with captivated washer	M5 screw with box clamp	
Rigid (solid & stranded) UL/CSA rated data	2x 2.5 – 6.0 mm ² 2x 14 – 10 AWG	1x 2.5 – 6.0 mm ² 1x 14 – 10 AWG	1x 2.5 – 25.0 mm ² 1x 14 – 3 AWG
Flexible with end sleeve	2x 1.0 – 2.5 mm ² 2x 2.5 – 4.0 mm ² 2x 18 – 14 AWG 2x 14 – 12 AWG	1x 1.0 – 4.0 mm ² 1x 18 – 12 AWG	1x 2.5 – 16.0 mm ² 1x 14 – 6 AWG
Flexible without end sleeve	2x 1.0 – 2.5 mm ² 2x 2.5 – 6.0 mm ² 2x 18 – 14 AWG 2x 14 – 10 AWG	1x 1.0 – 6.0 mm ² 1x 18 – 10 AWG	1x 4.0 – 25.0 mm ² 1x 12 – 3 AWG
Torque specifications	Posidrive bit 2 UL: 2.0 Nm (17.7 lb-in) IEC: 1.5 – 2.0 Nm (13.3 – 17.7 lb-in)	Posidrive bit 2 UL: 2.5 Nm (22 lb-in) IEC: 2.5 – 3.0 Nm (22 – 26.6 lb-in)	
Aperture for termination lug (fork or ring)	12.3 mm	n/a	
Protective Earth (PE) connection	M5, 1.5 Nm (13.3 lb-in) M5 PE screw is not provided with the solid state relay. PE connection is required when product is intended to be used in Class 1 applications according to EN/IEC 61140		

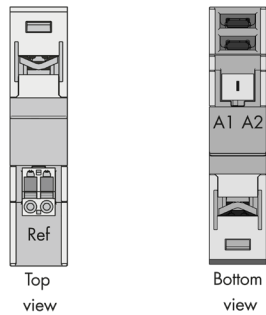
Control & Ref connection	
Terminals	Ref (x2 poles internally shorted on RG..N) A1+, A2- (RGM25 plug not provided) (not applicable for RGx1P..CM..N)
	
Conductors	Use 60/75°C copper (Cu) conductors
Stripping length	11 – 12 mm
Connection type	Spring plug, pitch 5.08 mm
Rigid (solid & stranded) UL/CSA rated data	0.2 – 2.5 mm ² , 26 – 12 AWG
Flexible with end sleeve	0.25 – 2.5 mm ²
Flexible without end sleeve	0.25 – 2.5 mm ²
Flexible with end sleeve using TWIN ferrules	0.5 – 1.0 mm ²
Ref internal short current handling capability	< 2 AAC

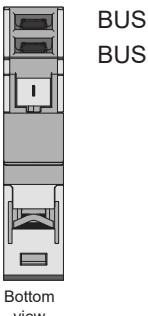
BUS connection	
Terminal	BUS (x2)
	
Type	RCRGN-xxx (where xxx refers to the length in cm) 5-way terminated with micro USB connector Cable lengths available: 10 cm RCRGN-010-2 25 cm RCRGN-025-2 75 cm RCRGN-075-2 150 cm RCRGN-150-2 350 cm RCRGN-350-2 500 cm RCRGN-500-2
Conductors	+24 V, GND, Data, Data, Autoconfigure line



RCRGN..

NRG internal BUS cable



Main features

- Cables available at various lengths to provide the internal BUS of the NRG system
- Cables terminated at both ends with a microUSB plug
- Connects the NRG controller to the RG..N solid state relay and respective RG..N solid state relays

Description

The **RCRGN** cables are proprietary cables that must be used with the NRG system for the internal BUS. These cables connect the NRG controller to the RG..N solid state relays and respective RG..N solid state relays.

The RCRGN... are 5-way cables carrying the communication, supply and autoconfiguration / auto-addressing lines. By means of autoconfiguration / auto-addressing, the RG..Ns are assigned a unique ID based on the physical location and on the internal BUS.

Carlo Gavazzi compatible components

Description	Component code	Notes
NRG Controller	NRGC..	<ul style="list-style-type: none"> • NRGC: NRG controller with Modbus communication. • NRGC-PN: NRG controller with PROFINET communication. • NRGC-EIP: NRG controller with EtherNet/IP communication. • NRGC-ECAT: NRG controller with EtherCAT communication. • NRGC-MBTCP: NRG controller with Modbus TCP communication. 1x RGN-TERMRES is included in the NRGC.. packaging. The RGN-TERMRES is to be mounted on the last RG..N on the bus chain.
Solid state relays	RG..N	NRG solid state relays

Order code

RCRGN - - 2

Enter the code entering the corresponding option instead of

Code	Option	Description	Notes	
R	-	Cables		
C	-			
R	-			
G	-		Suitable for the NRG system	
N	-			
<input type="checkbox"/>	010	10 cm cable length	packed x 4 pcs.	
	025	25 cm cable length	packed x 1 pc.	
	075	75 cm cable length	packed x 1 pc.	
	150	150 cm cable length	packed x 1 pc.	
	350	350 cm cable length	packed x 1 pc.	
	500	500 cm cable length	packed x 1 pc.	
2	-	Terminated at the both ends with a microUSB connector		



COPYRIGHT ©2022
Content subject to change.
Download the PDF: <http://gavazziautomation.com>