

P4D*

MODULAR SUBPLATES FOR ISO 4401-05 VALVES

- This series of modular subplates has been designed to make hydraulic circuits and can be used directly on power packs or on any other section of the machine.
- The subplates are assembled by means of 4 tie-rods with seal seats incorporated in the subplate.
- The above assembly achieves compact units (including pressure and discharge manifolds): one face per subplate is used for connection to services and the other to mount ISO 4401-05 or ISO 4401-03 valves.
- Complex circuits can also be set up using modular valves.
- The recommended mounting configuration for **P4D** subplates on hydraulic power packs is with the main axis positioned vertically to obtain the bundle of pipes to utilities in two vertical rows; however, assembly is not restricted to this configuration.

p max **350** bar
Q max **100** l/min

TECHNICAL SPECIFICATIONS

Maximum operating pressure - ports P - A - B - port T	bar	see paragraph 8 140
Maximum flow	l/min	100
Ambient temperature range	°C	-20 / +60
Fluid temperature range	°C	-20 / +80
Fluid viscosity range	cSt	10 ÷ 400
Fluid contamination degree	cSt	25
Recommended viscosity	According to ISO 4406:1999 class 20/18/15	

1 - IDENTIFICATION CODE

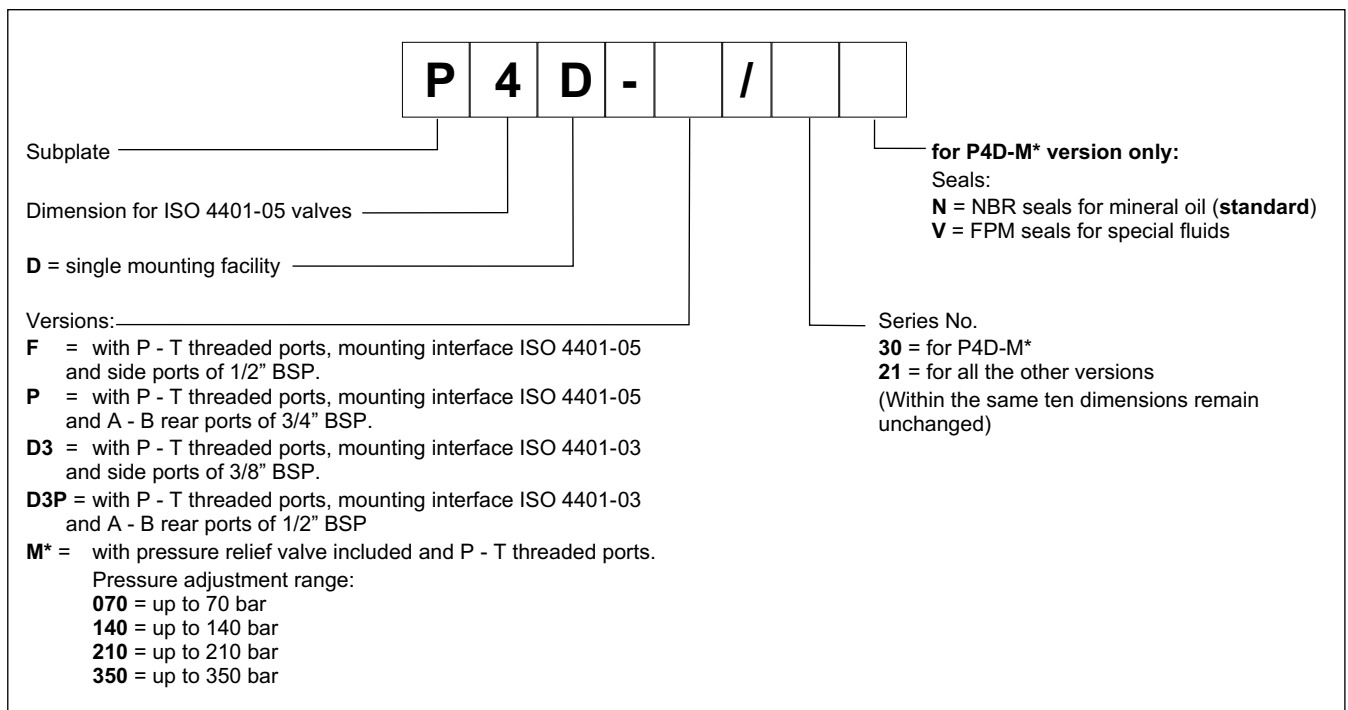

2 - OVERALL AND MOUNTING DIMENSIONS P4D-F/21 (COD. 1561441)

P - T THREADED PORTS SUBPLATE, WITH MOUNTING INTERFACE FOR ISO 4401-05 VALVE AND A-B SIDE PORTS OF 1/2" BSP

dimensions in mm

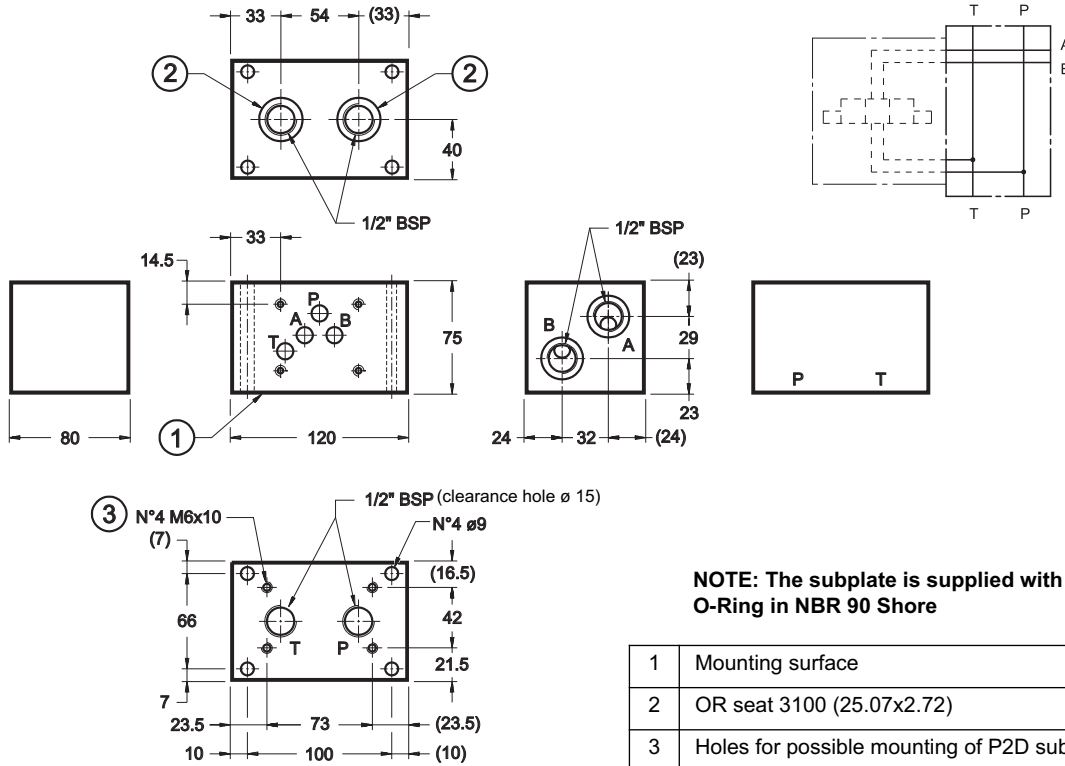

Mass: kg 4,8

3 - OVERALL AND MOUNTING DIMENSIONS P4D-P/21 (COD. 1561461)

P - T THREADED PORTS SUBPLATE WITH MOUNTING INTERFACE FOR ISO 4401-05 VALVE AND A -B REAR PORTS OF 3/4" BSP

dimensions in mm

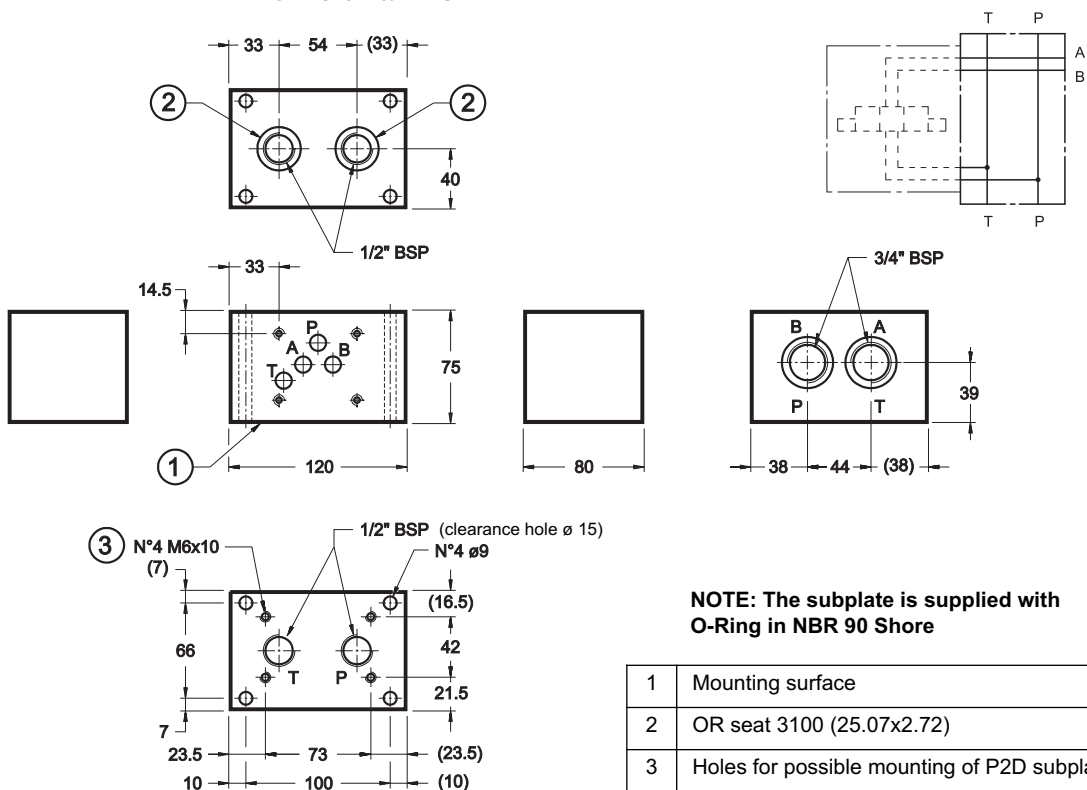

Mass: kg 4,8

4 - OVERALL AND MOUNTING DIMENSIONS P4D-D3/21 (COD. 1561451)

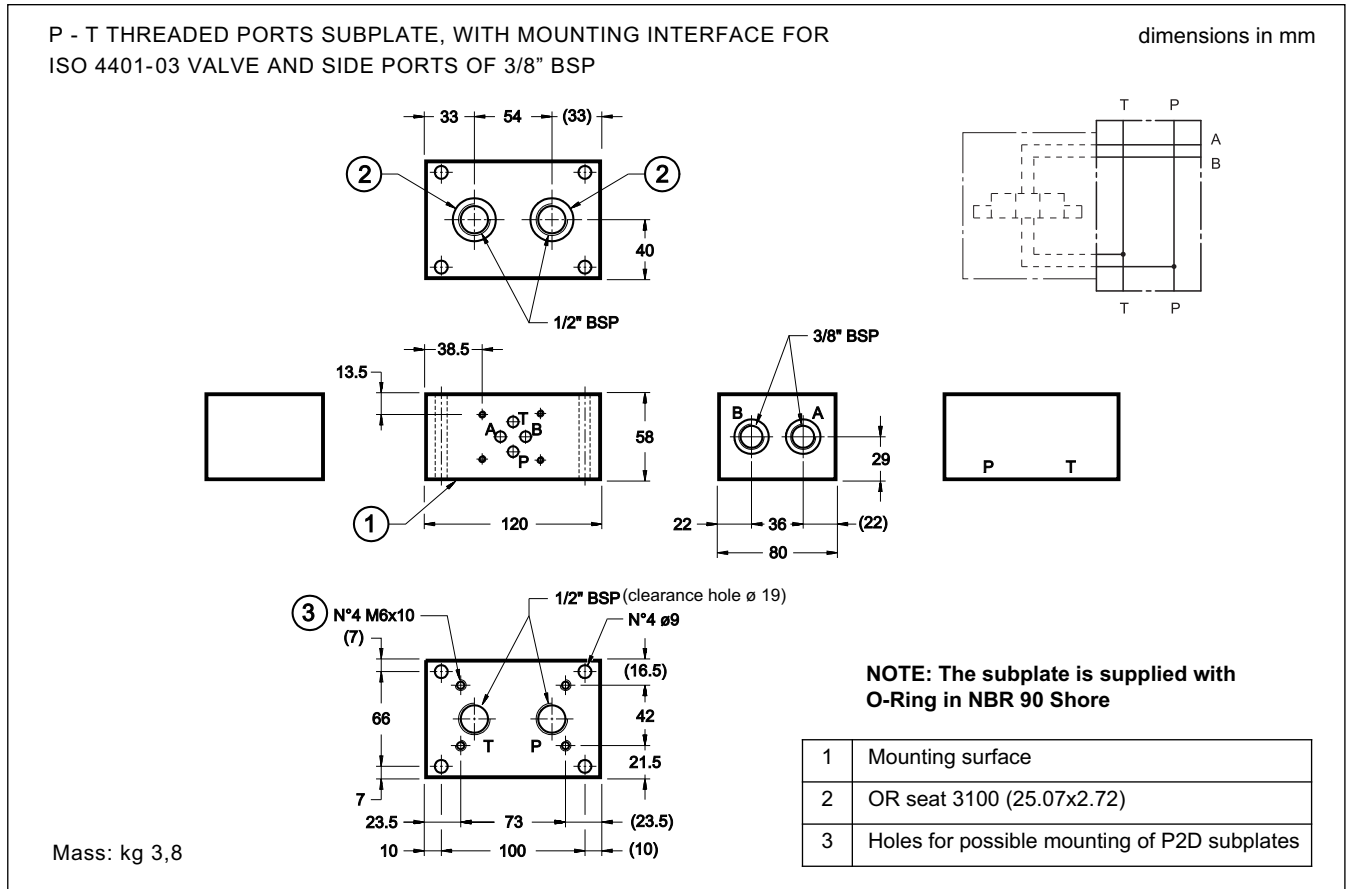

5 - OVERALL AND MOUNTING DIMENSIONS P4D-D3P/21 (COD. 1561481)

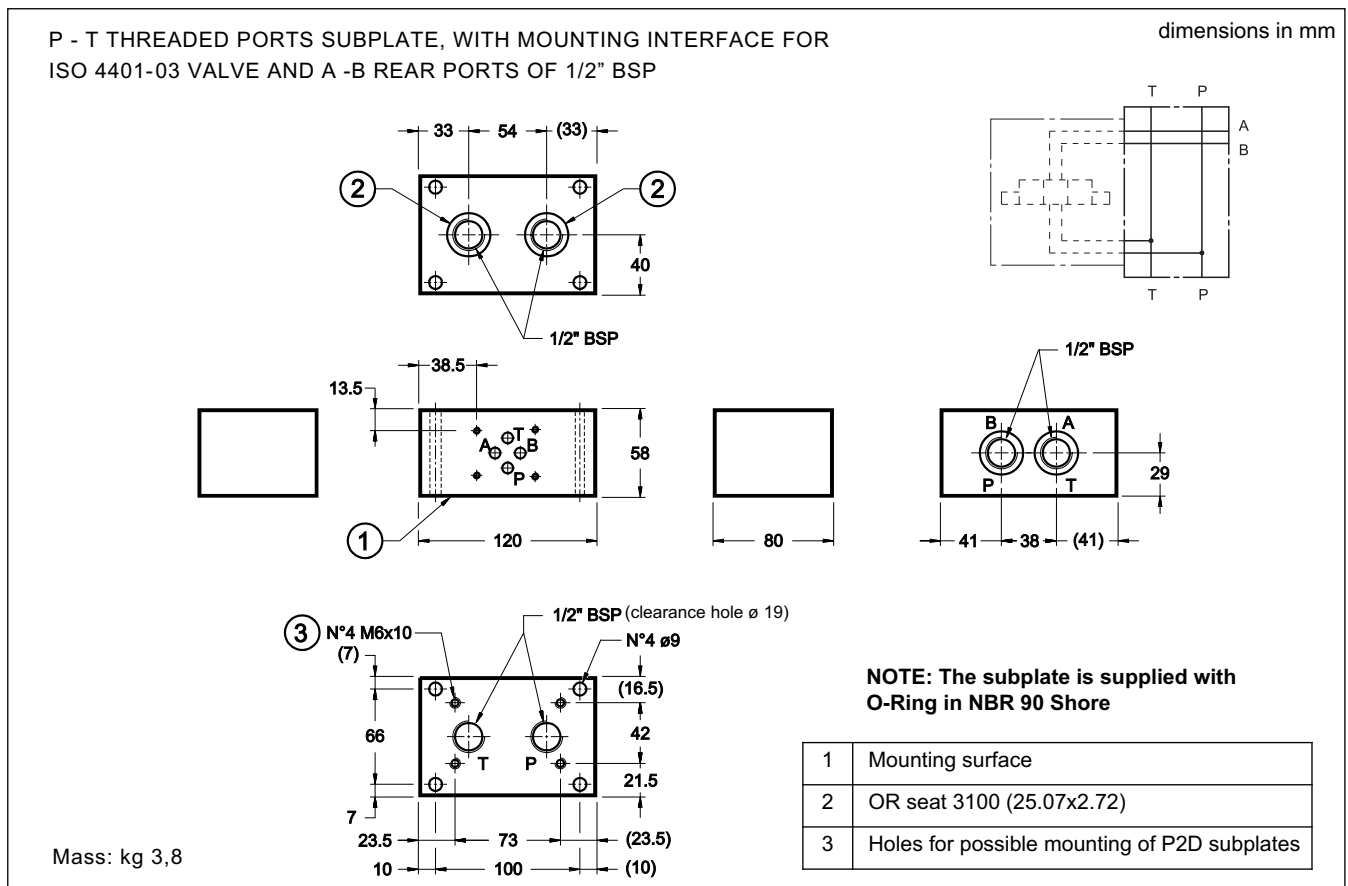

6 - OVERALL AND MOUNTING DIMENSIONS P4D-M*/30

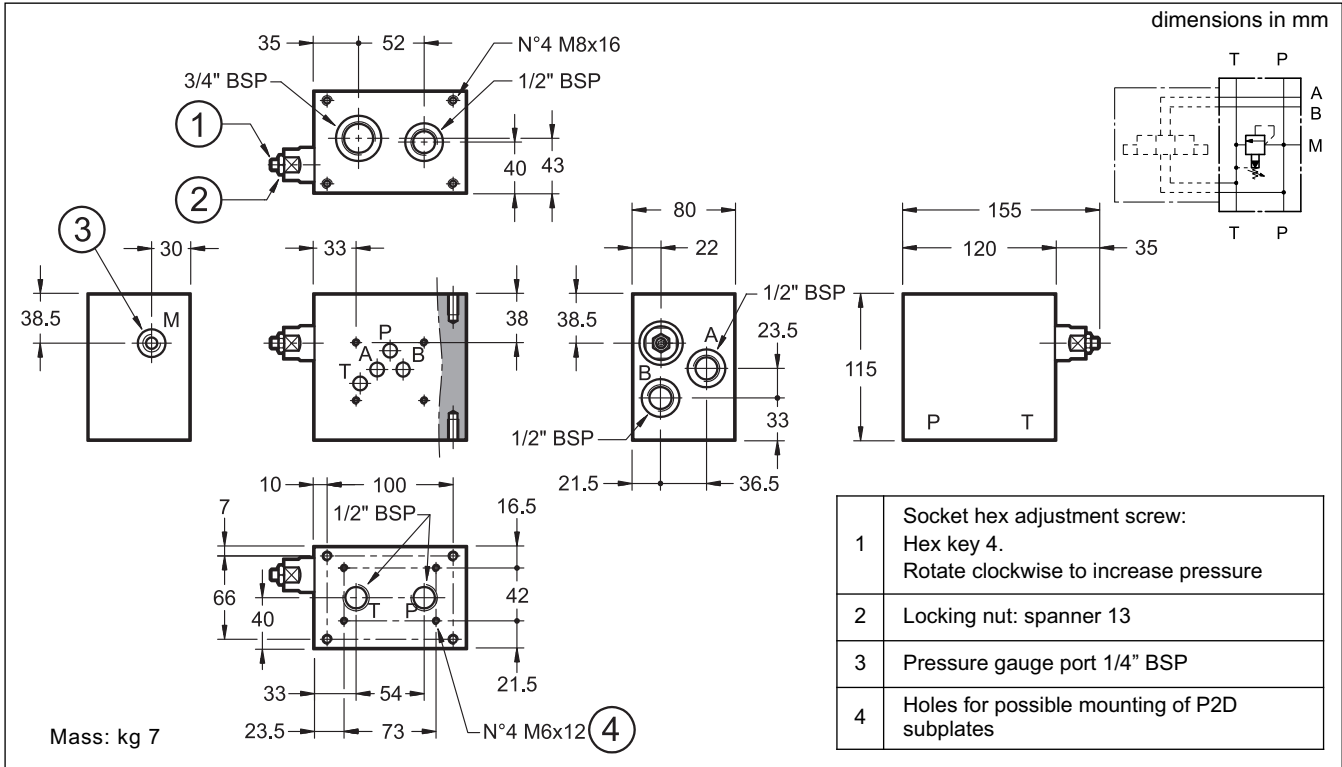

7 - CHARACTERISTIC CURVES

(values obtained with viscosity of 36 cSt at 50°C)

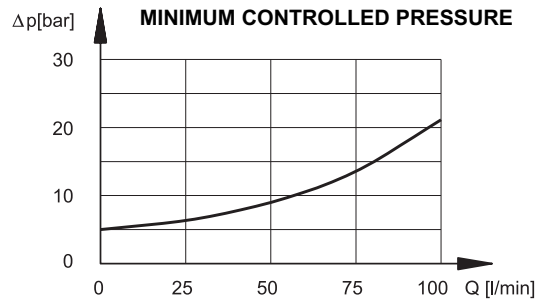
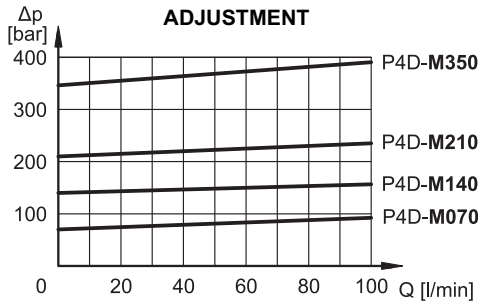

8 - MAXIMUM PRESSURE ON P

Depending on the tie-rod type and on the number of assembled subplates it is necessary to pay attention to the maximum pressure on P in order to avoid extruding the O-Ring.

No. of assembled subplates	Threaded bar class B7 ISO 6547 (DIN 975)	Stud class 8.8 UNI 5911	Stud class 12.9
2	350 bar	350 bar	350 bar
3	300 bar	350 bar	350 bar
4	250 bar	300 bar	350 bar
5	200 bar	250 bar	300 bar
6	150 bar	200 bar	250 bar
Tightening torque	20 Nm	20 Nm	30 Nm